

On Modeling Complex Micro-Scale Systems: What Are The Equations?

Benjamin Shapiro

Aerospace engineering / Bio-engineering /

Institute for Systems Research

benshap@eng.umd.edu



UNIVERSITY OF
MARYLAND

We're interested in the mechanics of *living cells*. Have a room full of mathematicians (good) but we don't even know the right equations yet (bad). The purpose of this talk is to generate ideas on how to create a path from where we are to *useful* model eqn's.

Lets start with a comparison: 2 examples I've worked on (1 macro, 1 micro), and the living cell.

Jet-engine: macro-scale, inanimate

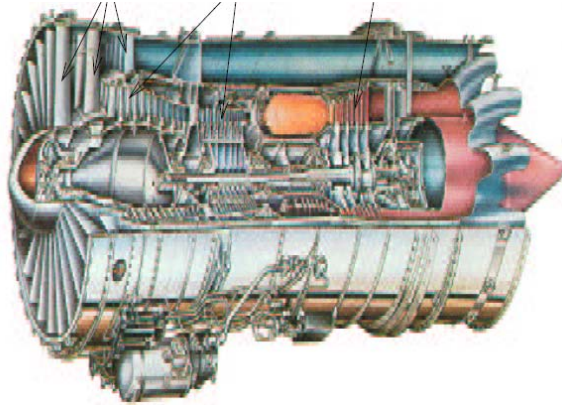
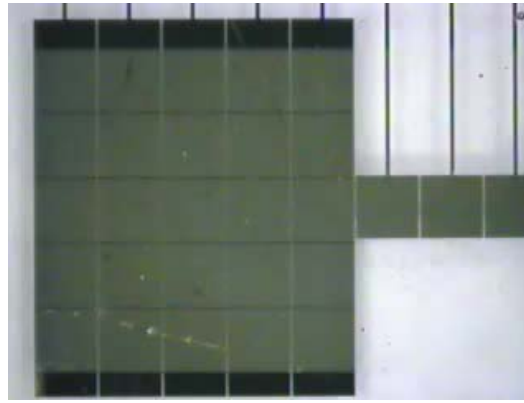

Figure courtesy Pratt & Whitney (from Shapiro thesis)

- COMPLEX
- Macro-scale
- Equations largely known (fluid dynamics, heat transfer, mechanics). For combustion, equations not known.
- Can take apart, analyze/ model/ test/ validate one component at a time.

Electrowetting: micro, inanimate



movie courtesy CJ Kim, UCLA

- COMPLEX
(I'm not showing you the micro-fabrication details underneath)
- Micro-scale
- In 2002, equations were not known. Now, in 2007, do know eqn's, have predictive models.
- Can take apart, analyze/ model/ test/ validate one component at a time.

The cell: micro-scale, alive

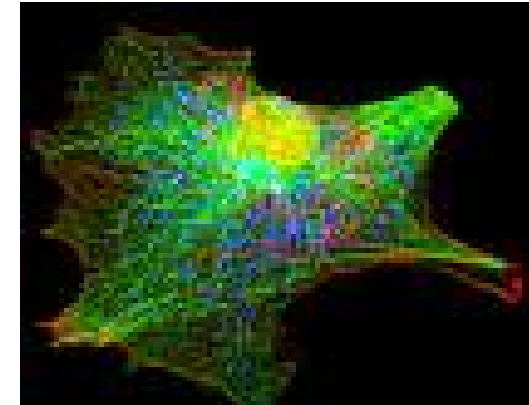

www.contrib.andrew.cmu.edu/usr/pv28/journey.html

- COMPLEX
- ALIVE
- Micro-scale
- Equations unknown: still governed by known physical laws (thermo, chemistry, Newton's laws) but to such detail (~30,000 nanoscale machines [proteins] per cell) that *must* choose simpler mathematical representations.
- Can't take apart: will kill cell.

We're interested in the mechanics of *living cells*. Have a room full of mathematicians (good) but we don't even know the right equations yet (bad). The purpose of this talk is to generate ideas on how to create a path from where we are to *useful* model eqn's.

Lets start with a comparison: 2 examples I've worked on (1 macro, 1 micro), and the living cell.

Jet-engine: macro-scale, inanimate

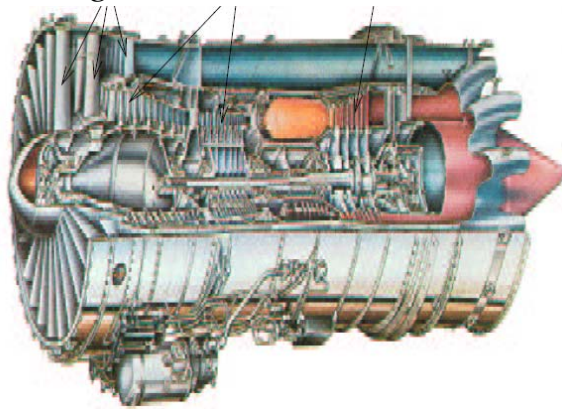
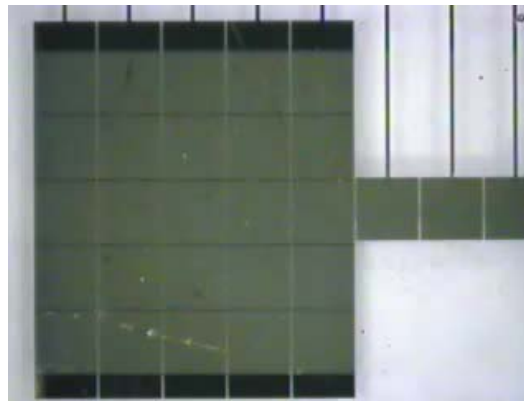

Figure courtesy Pratt & Whitney (from Shapiro thesis)

- COMPLEX
- Macro-scale
- Equations largely known (fluid dynamics, heat transfer, mechanics). For combustion, equations not known.
- Can take apart. analyze/

Electrowetting: micro, inanimate



movie courtesy CJ Kim, UCLA

- COMPLEX (I'm not showing you the micro-fabrication details underneath)
- Micro-scale
- In 2002, equations were not known. Now, in 2007, do know eqn's, have predictive

The cell: micro-scale, alive

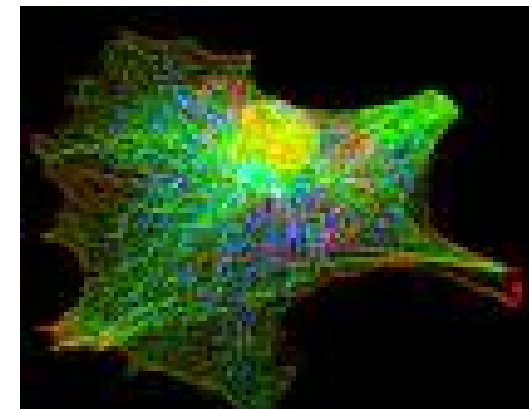

www.contrib.andrew.cmu.edu/usr/pv28/journey.html

- COMPLEX
- ALIVE
- Micro-scale
- Equations unknown: still governed by known physical laws (thermo, chemistry, Newton's laws) but to such

Disclaimer: I don't know how to get equations for a living cell. But maybe if we put some minds together (in physics, cell-experiments, and mathematics) then we can try figure out a path. I do know we need to be more systematic about how we go about doing this.

- mathematical representations.
- Can't take apart: will kill cell.

I'll start by how we came up with governing equations for two micro-scale examples:

- 1) Equations for *electrowetting*: the actuation of micro-flows by electrical modulation of surface tension.
- 2) Equations for *conjugated polymer actuators*: a plastic that conducts electricity, can be micro-patterned, and can be actuated inside ionic solutions (e.g. in urine, blood).

In both cases, it is *not* clear from the description *which* physics matters.

E.g. which physical phenomena causes an electric field to modify surface tension?

Answering this question is a) difficult and b) a pre-requisite to writing down a math model. First I need to decide which physics to include, only then can I write down equations describing those physical mechanisms.

I'll end with some suggestions on how I think we should proceed to do the same for living cells.

Electrowetting: actuation of micro-flows by
electrical modulation of surface tension

Here is the simplest electrowetting experiment ...

Put a single drop of water on a hydrophobic (hates water) surface (e.g. Teflon), which coats an underlying dielectric insulator (here silicon dioxide). Apply a voltage between the drop and bottom. Droplet will change shape.

Only had empirical eqn to predict angle which only worked at low voltages.

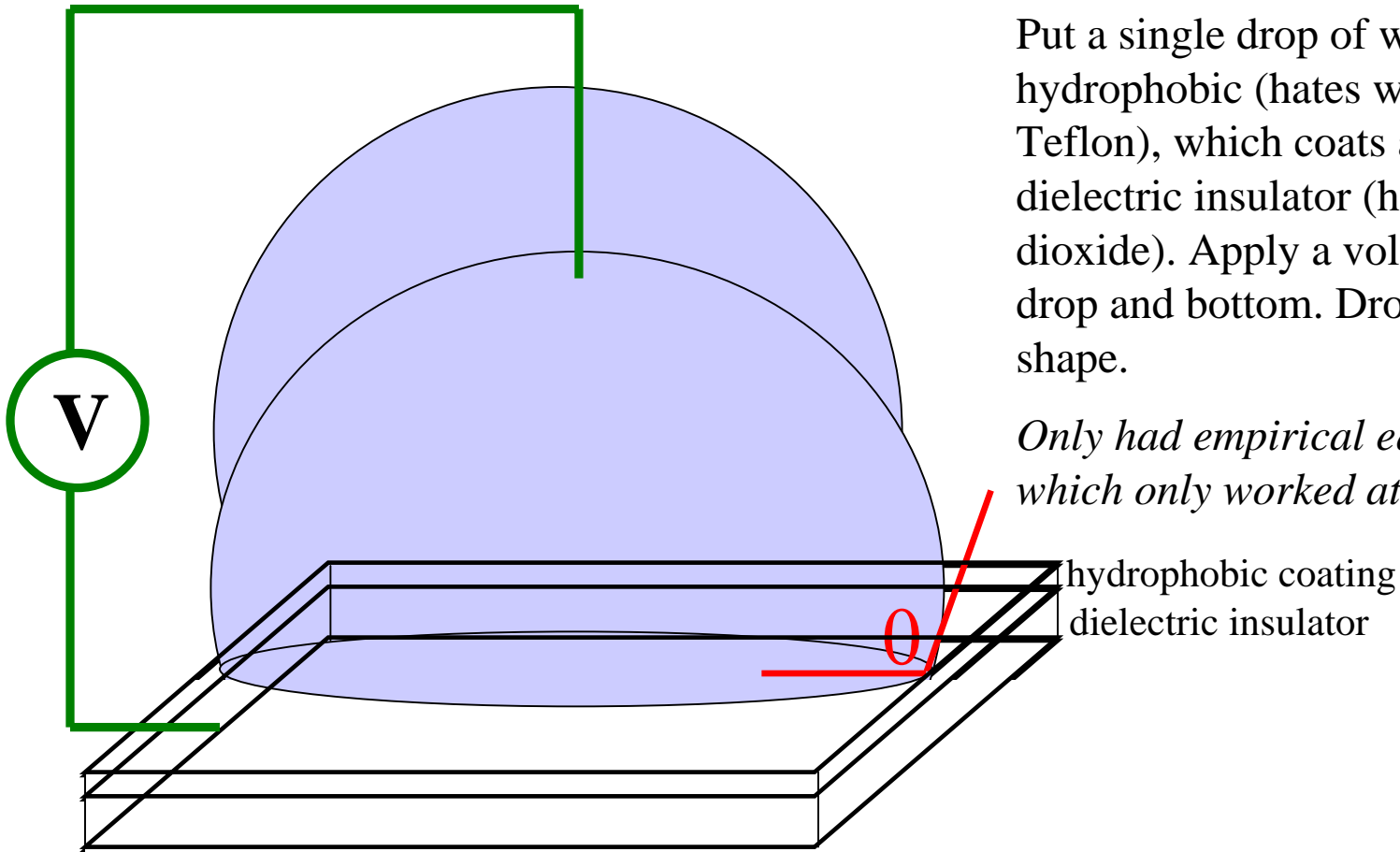

Example: Drop Motion by Electro-Wetting-On-Dielectric (fig. courtesy Jeong-Yeal Yoon, UCLA)

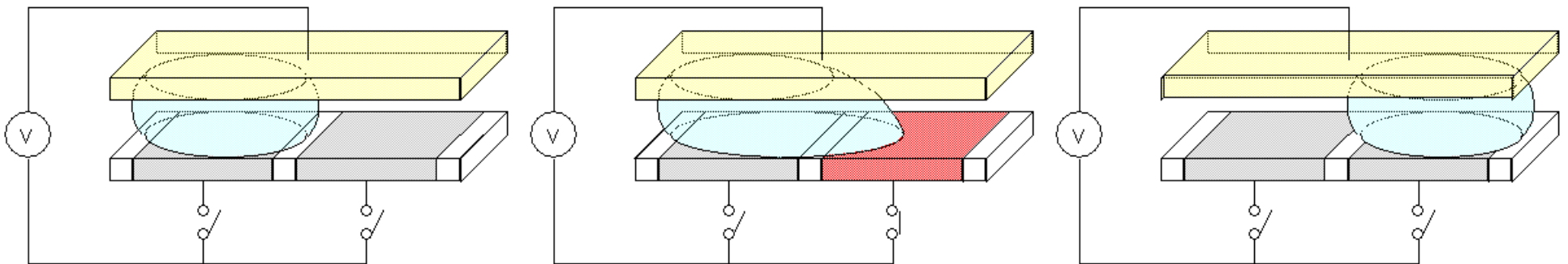

Here is what makes electrowetting systems complicated ...

(this slide is from *before* we knew which physics dominated electrowetting systems)

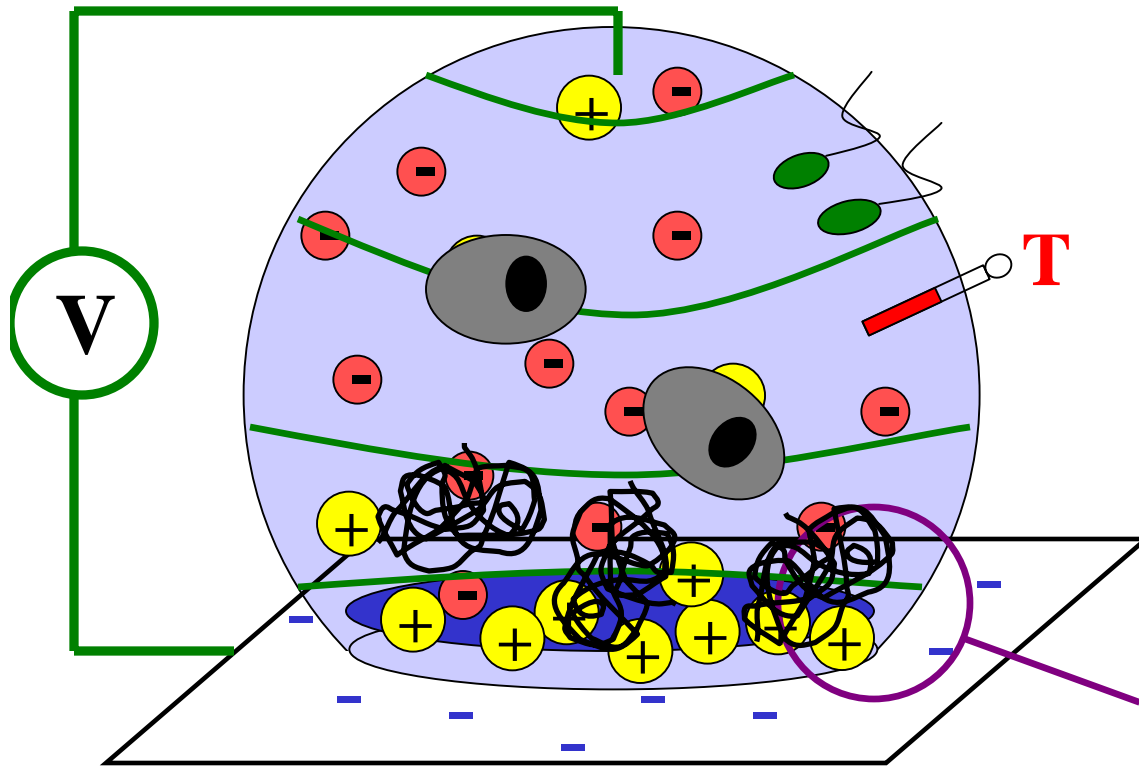

Surfactants can change surface tension properties dramatically

Surface tension varies with temperature, humidity, ...

Chemical species effect surface tension: these can concentrate in double-layers at charged interfaces

Interplay between viscous and surface tension forces at triple phase boundaries

And then we add in some electric fields:

Now get dielectric polarization, current flow, dielectric breakdown, ...

And just to make things interesting, add in bio-molecules (proteins, DNA, cells, ...): these will diffuse, adsorb/desorb, change shape, ...

I had experimental data (from UCLA) and nonsensical papers that stated equations without stating underlying physical assumptions.

Almost all papers started with the Young-Lippman equation

$$\sigma_{lg} \cos \theta = - (\sigma_{ls} - \sigma_{\sigma\gamma} - \epsilon V^2/2h)$$

which gave equilibrium contact angle as a function of voltage. It only worked for low voltages. At high voltages, it predicted you could turn a drop into a thin film by applying a high enough voltage (false in the experiments). It had no dynamics.

Based purely on what seemed reasonable at the time ...

I asked a specific question whose answers I could test vs. UCLA data:

What is the equilibrium deformation of the drop as a function of voltage?

I literally made a list of all physical effects I could think of based on the previous figure (it had about 30 items: e.g. 1) concentration of ions at the solid/liquid surface locally changes surface tension at the solid/liquid interface [turns out is true but negligible], 5) capacitance in the ion double layer [irrelevant], 17) capacitive charge of the dielectric [the dominant effect] + others I can no longer remember).

For each item I did back-of-the-envelope calculations to estimate energy used up by that physical effect. I removed items that had energy content < 1% of that supplied to the system. This was incredibly useful. It cut down the list from 30 to 3 in about 1 week. It also annoyed my chemistry collaborator who was convinced of item 1).

So here is why the liquid droplet shape changes with applied voltage ...

Consider a conducting liquid on a dielectric solid ...

Now apply a voltage

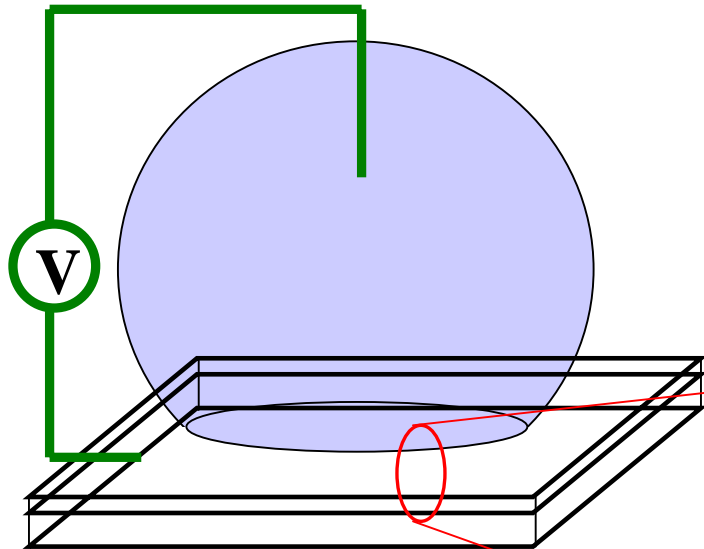

... the energy, with no applied voltage, is:

$$E_{st} = (\sigma_{ls} - \sigma_{sg}) A_{ls} + \sigma_{lg} A_{lg}$$

... and so include the electrical energy,

This has 2 parts:

i) Capacitive energy in the dielectric:

Energy per unit volume: $dE = \frac{1}{2} \vec{D} \cdot \vec{E}$
 (\vec{D} is polarization per unit volume)

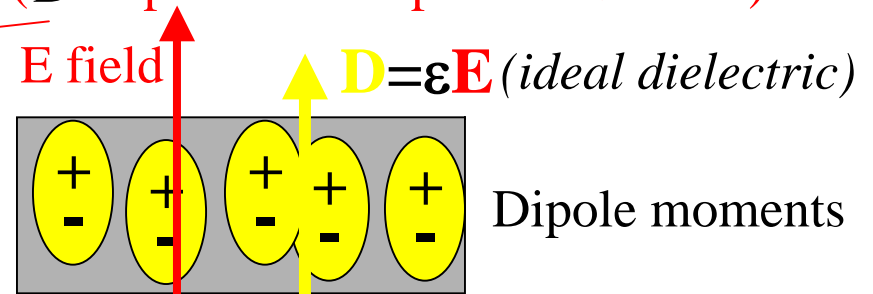

Dielec. energy: $E_{de} = \frac{1}{2} \epsilon (V/h)^2 h A_{ls}$

ii) Potential energy stored in the voltage source is always twice the energy stored in the dielectric but with opposite sign:

$$E_{de} = - \epsilon (V/h)^2 h A_{ls}$$

Total: $E = (\sigma_{ls} - \sigma_{sg}) A_{ls} + \sigma_{lg} A_{lg} - \frac{1}{2} \epsilon (V/h)^2 h A_{ls} = (\sigma_{ls} - \sigma_{sg} - \epsilon V^2/2h) A_{ls} + \sigma_{lg} A_{lg}$

Corresponding Young equation: $\sigma_{lg} \cos \theta = - (\sigma_{ls} - \sigma_{sg} - \epsilon V^2/2h)$.

Gives a derivation of YL eqn, but says voltage can change a drop into a film (false).

So the next (equilibrium) question was saturation:

Why is it that as the voltage is increase the change in angle saturates, stops following the Young-Lippman equation?

It turns out that there is no unique answer to this. It depends on the system. The Young-Lippman equation is the ideal case, any physical loss mechanism will destroy it. The question becomes: *which loss mechanism appears first in your electrowetting system?*

We still don't definitively know the answer to this question. From the list of 30, the item that best seems to explain the *UCLA data* is electrical resistance in the liquid. Like this ...

Why drop stops changing shape (in UCLA devices) = **liquid resistance**.

Qualifier: Many other physical effects can (potentially) cause contact angle saturation: electrolysis, electrostatic/capillary instabilities, ionization of air in the vicinity of the triple line, charge/ion adsorption from liquid to the solid surface, charge trapping, non-ideal dielectrics, ...

If liquid is a perfect conductor \rightarrow get constant $\phi=V$ potential at the liquid/solid interface \rightarrow stored capacitive energy is proportional to volume which is proportional to liquid/solid area A_{ls} .

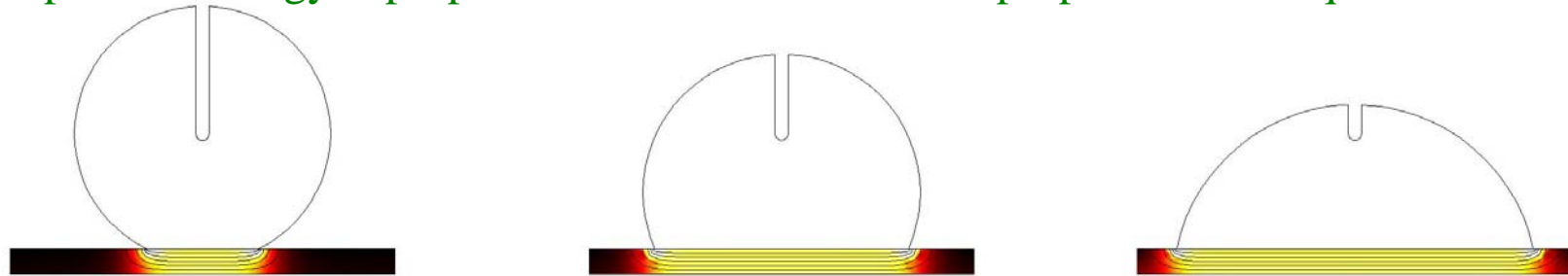

Color = stored dielectric energy per unit volume in the solid: high, medium, zero

If liquid has small resistance \rightarrow **average** resistance increases with decreasing contact angle (close to no-wetting: all liquid paths from wire to solid are short; close to total spreading: both long and short paths) \rightarrow stored energy deviates away from the ideal (proportional to A_{ls}) value.

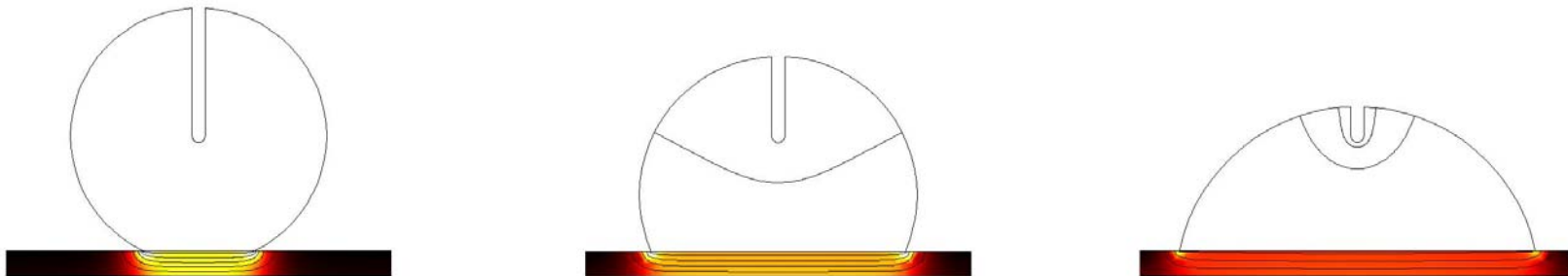

Result: Imposed electrical energy can no longer exactly cancel liquid/solid surface tension energy for all possible contact angles.

The details ...

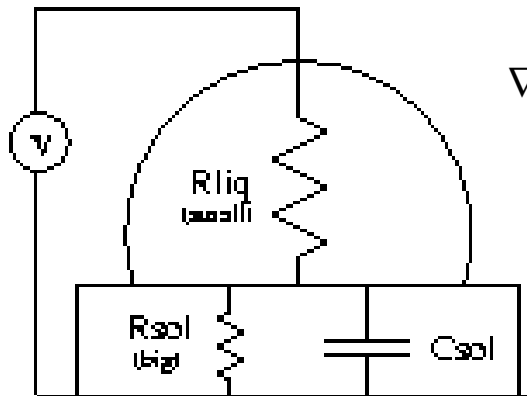

Equivalent circuit diagram

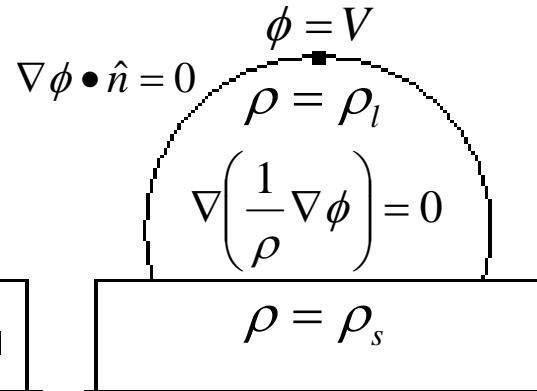

PDEs $\phi = 0$

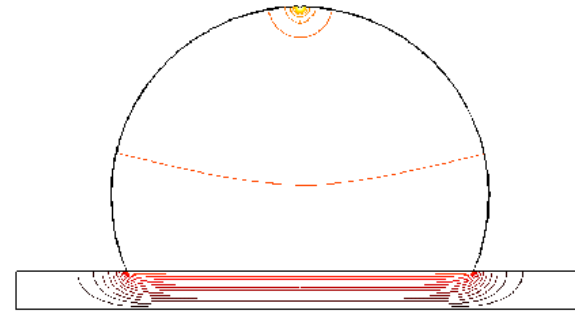

Sample solution: ϕ contours

No liquid resistance

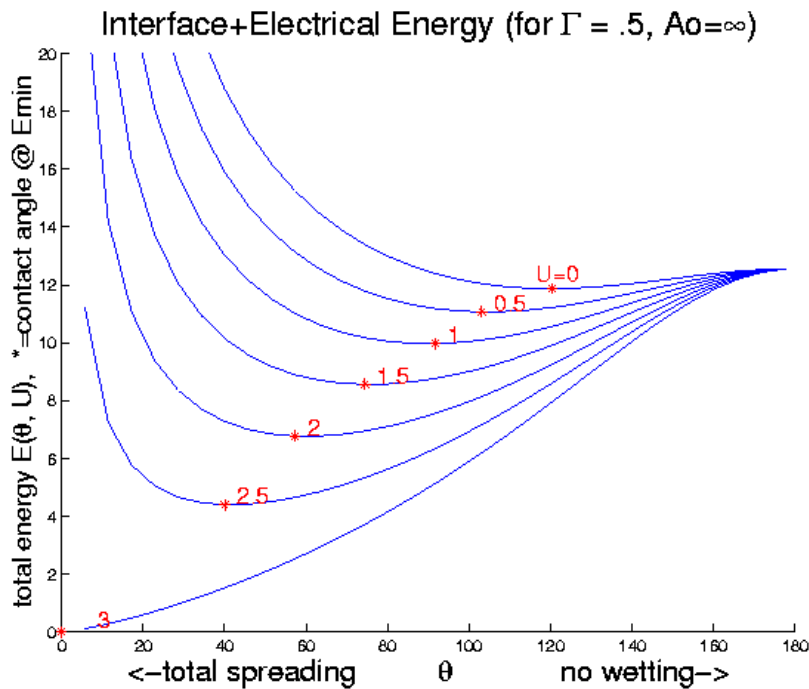

$$U = \epsilon V^2 / h \sigma_{lg}$$

With liquid resistance

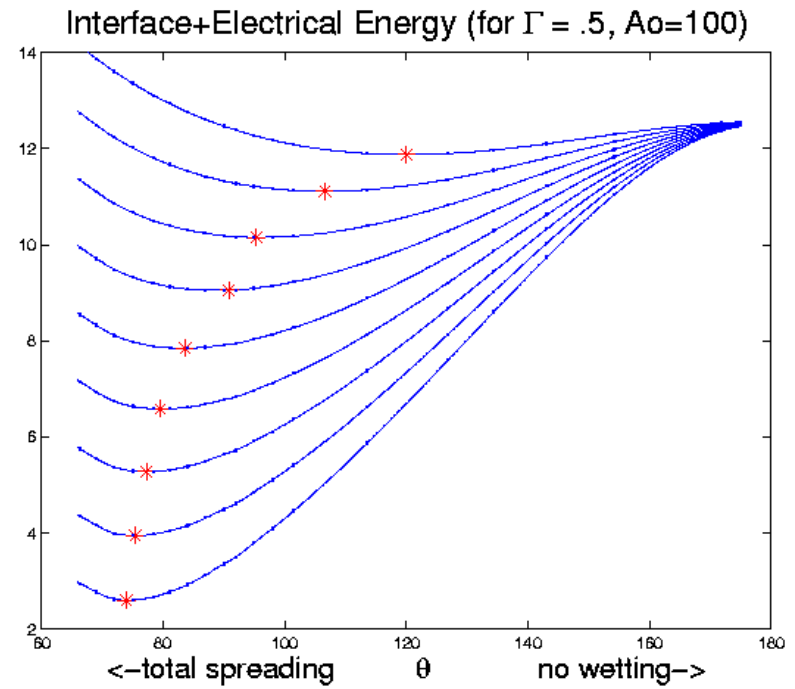

$$Ao = \text{net sol/liq resistance} = \rho_s h / \rho_l R$$

Contact Angle versus U for Experiment and Theory

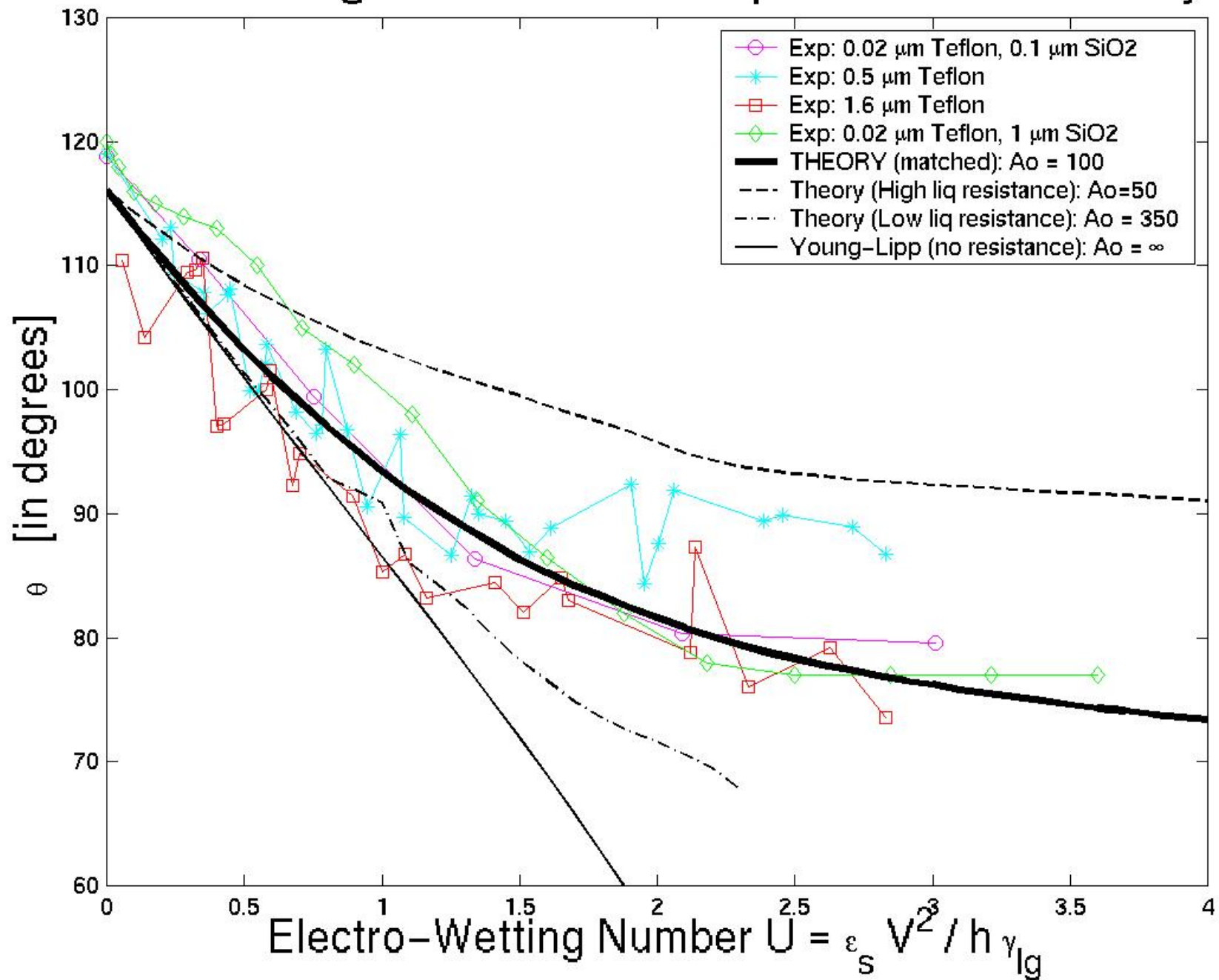

Then the question become how to address electrowetting dynamics.

All the interesting parts, the electrowetting parts of the physics, we now understood reasonably well, and they were fast (quasi-steady during dynamics).

It remained to write down equations for the fluid flow. We already knew the equations for micro-flow dynamics = the low Reynolds number limit of the Navier Stokes equations. Shawn Walker did a careful dimensional analysis to figure out which terms in the bulk and the boundaries (surface tension, curvature in which directions, etc) mattered. Based on this, he derived a set of governing PDEs.

The modeling challenge then largely become one of numerical methods, of tracking moving interfaces (Shawn Walker, and now Ricardo Nochetto).

Note: We now have models that are “85% good” (I don’t know how to quantify how good: they work great in most cases but miss a few features in some cases). The physics for those missing features, e.g. details of triple line (liquid/solid/gas) motion, are still unknown. We are applying the same kind of process again to describe them.

b) PDEs +c) Numerics: our simulations (as of March 06)

Have experimentally validated model of fluid dynamics in the UCLA EWOD devices

a) Physical assumptions:

- 1) Device length scale \gg mean free path of air and water (continuum assumption is ok),
- 2) Ignore airflow, 3) Liquid flow is parabolic in z , 4) Electrostatics is fast compared to fluid flow (interface in equilibrium w.r.t. voltage), and 5) Small Reynold's number.

Averaged over flow in the z direction.

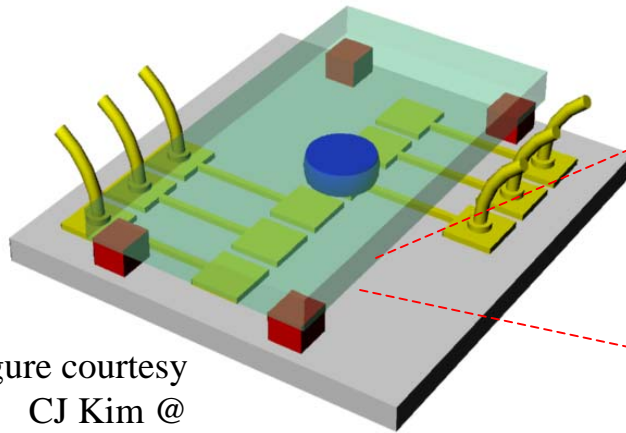
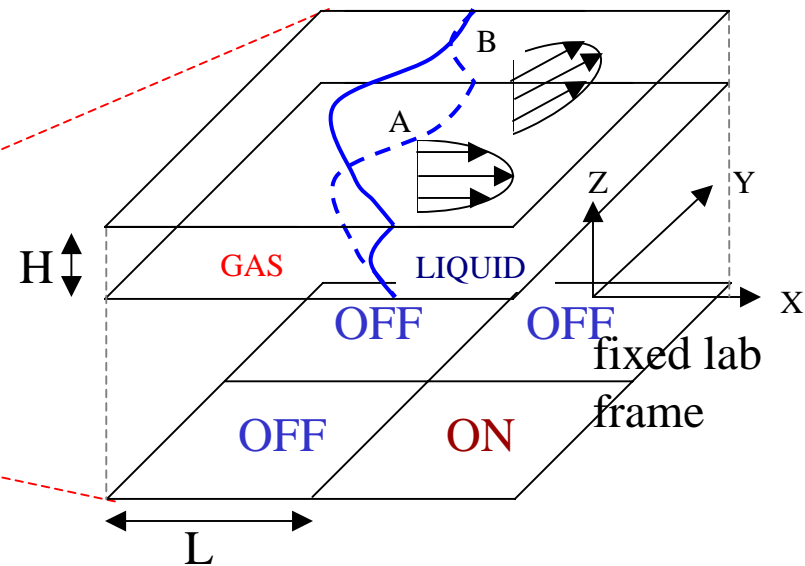

Figure courtesy
CJ Kim @
UCLA



b) Then 3D Navier Stokes reduce to modified 2D Hele-Shaw equations (in non-dim form):

$$\nabla^2 p = 0, \quad \tau \frac{\partial \bar{V}}{\partial t} + \beta \bar{V} = -\frac{1}{Ca} \nabla p, \quad \text{with} \quad \tau = \frac{\rho L U_0}{\mu}, \quad \beta = 12 \left(\frac{L}{H} \right)^2$$

Momentum convection and horizontal diffusion are negligible. Vertical diffusion is accounted for by the parabolic in z flow profiles. Local momentum changes important if apply rapid electrical actuation.

b) PDEs +c) Numerics: our simulations (continued)

Shawn Walker
Benjamin Shapiro

a) Physical assumptions (continued):

Interface convected by local velocity

$$\frac{d}{dt} \Psi = \vec{V}(\Psi),$$

Interface pressure set by 3D curvature set by contact angles

$$p(\Psi) = \kappa_{xy} - \frac{L}{H} (\cos\theta_t + \cos\theta_b)$$

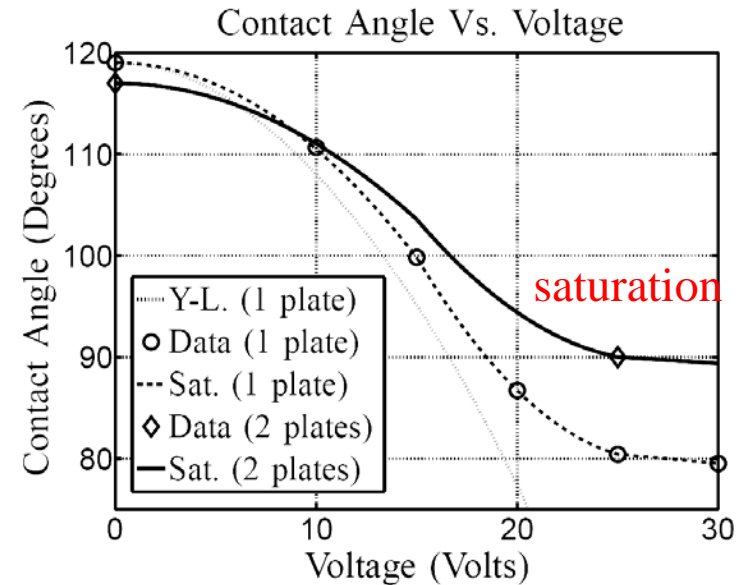
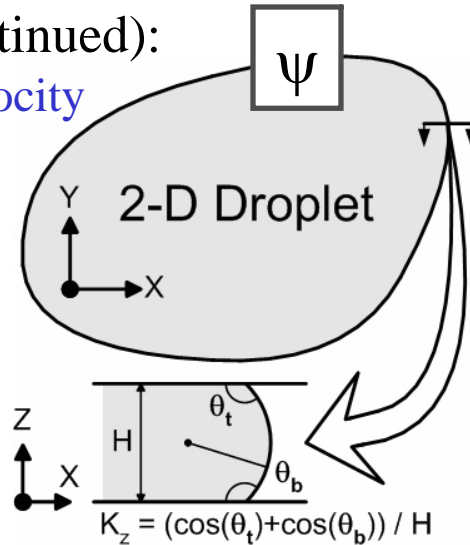

And must also include hysteresis to match experimental data. 1st try: $\nabla p \rightarrow K_{hys} \nabla p$

No losses (Young-Lippman)
= *x12 too fast + spurious satellite drop*

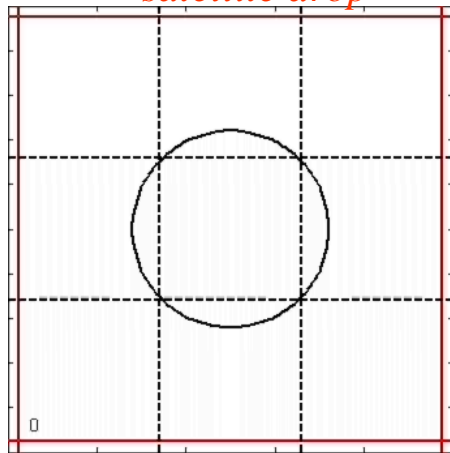

Saturation only
= *x7 too fast*

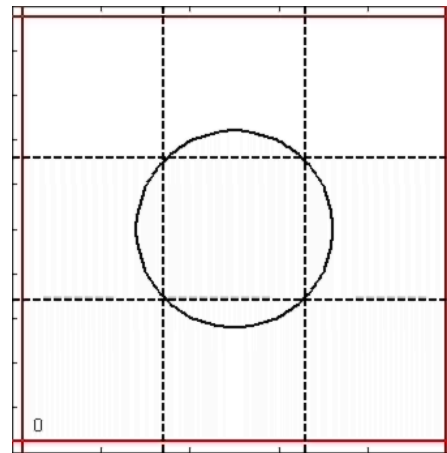

Saturation & Hysteresis
= *matches split exp*

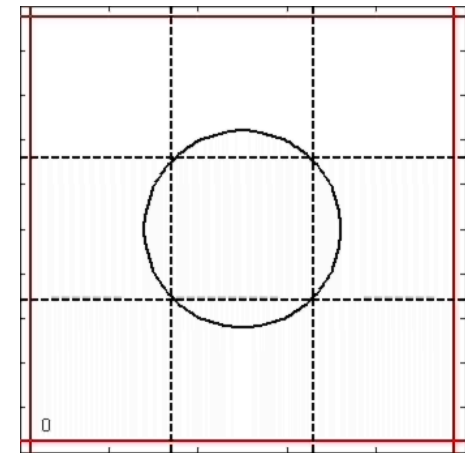

d) Experimental validation: [our simulations \(continued\)](#)

(b) Have governing PDEs. (c) Track interfaces by level set method. Model runs in 3-6 min.

(d) Fluid Dynamic
EWOD Simulation
versus Experiment

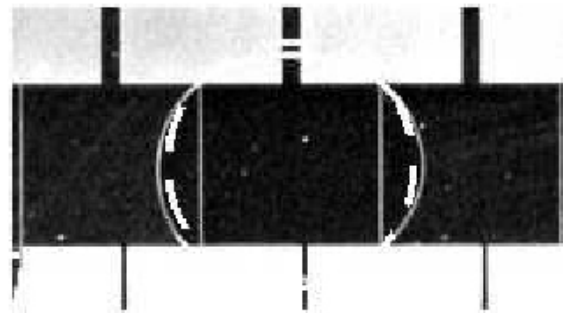
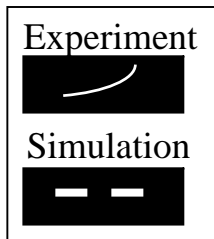

(a) Time: 0 ms.

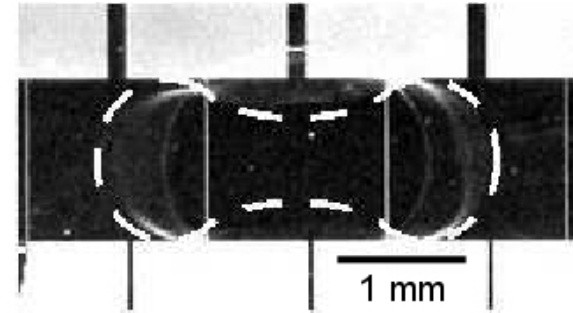

(b) Time: 33.33 ms.

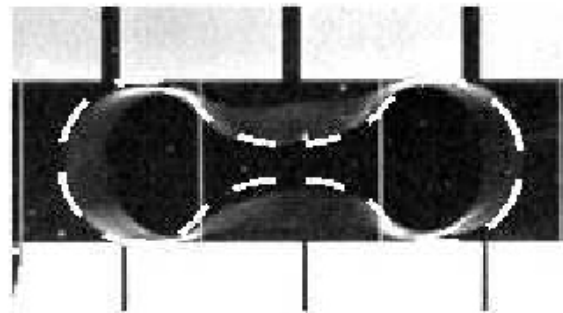

(c) Time: 66.67 ms.

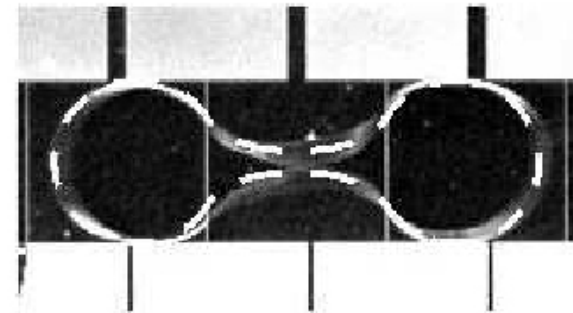

(d) Time: 100.0 ms.

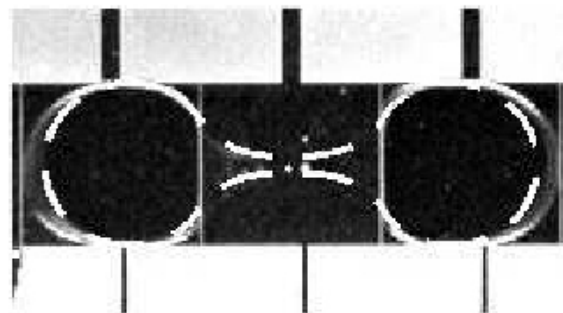

(e) Time: 133.33 ms.

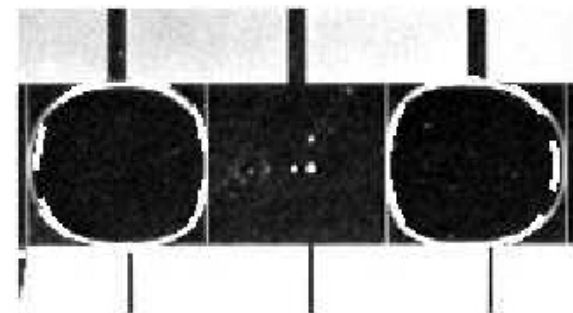

(f) Time: 166.67 ms.

For further details see:
S.Walker, B.Shapiro,
"Modeling the Fluid
Dynamics of Electro-
Wetting On Dielectric
(EWOD)", Journal of
Micro-electro-mechanical
Systems (JMEMS). In-
press 6 Jan 2006.

a-d) Simulations of pinning: force threshold (new!)

But 1st cut hysteresis model is not good enough, e.g. does not pin mild elliptical shapes and prevent them from becoming circles (this happens in the experiments).

Here is our 2nd try at a pinning model ...

- a) New physical assumption: maximum line pinning force
- Specifically: $|\text{force per unit line length}| \leq c$, a material dependent coefficient measured experimentally (e.g. by droplet tilt exp).
 - When pinned: averaging over z gives $|P - P_\infty| = |\Delta P_{\text{pin}}| \leq 2c/H$.

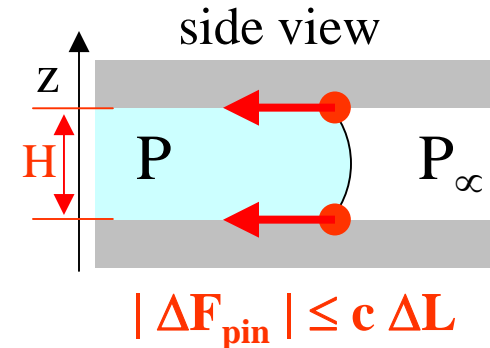

- b) Governing equations: same as before, but boundary conditions switch between
- Free if $|P - P_\infty| = |\Delta P_{\text{pin}}| > 2c/H$, apply $P(\partial\Psi) = [\kappa_{xy} - L \cos(\theta_t + \theta_b)/H] - (2c/H) \text{sign}(\vec{V} \cdot \hat{n})$
 - Pinned if $|P - P_\infty| = |\Delta P_{\text{pin}}| \leq 2c/H$, apply $\vec{V} \cdot \hat{n}(\partial\Psi) = 0$

- c) Numerical implementation: iterate to find location of free/pinned boundary segments

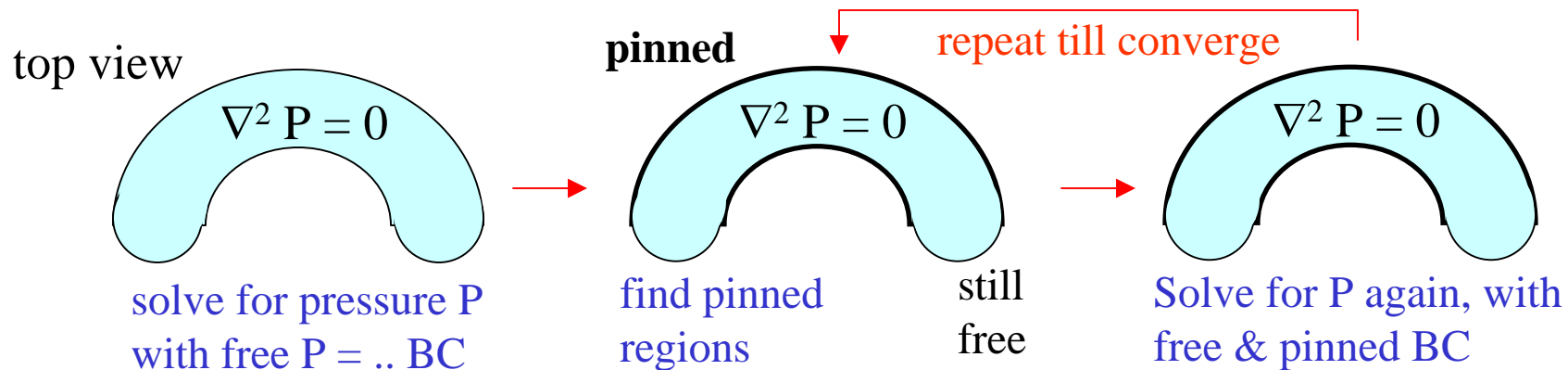

a-d) Simulations of pinning: force threshold (new!)

d) Initial simulation results with force threshold pinning.

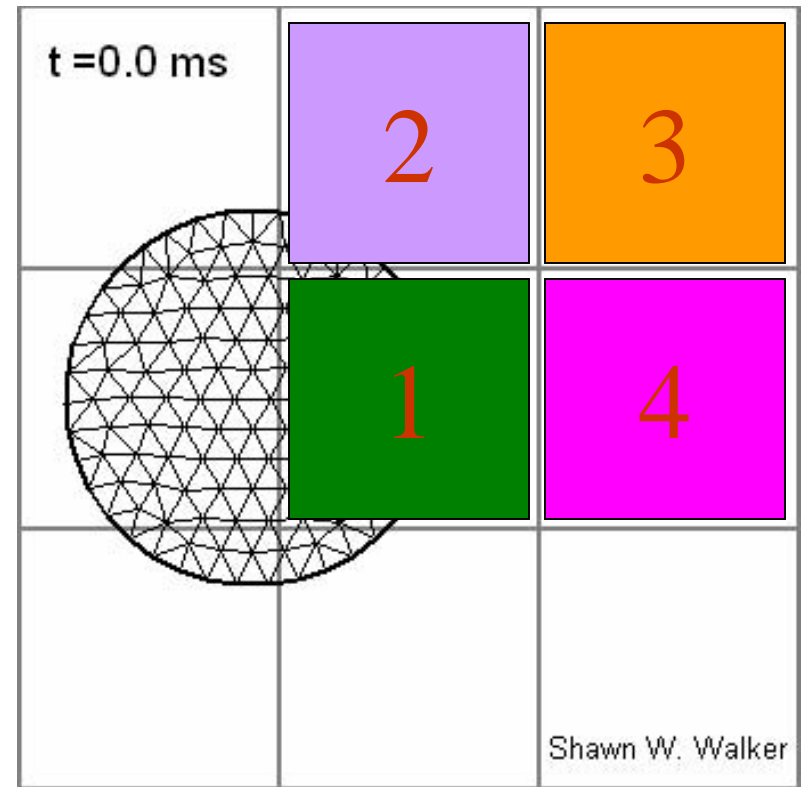
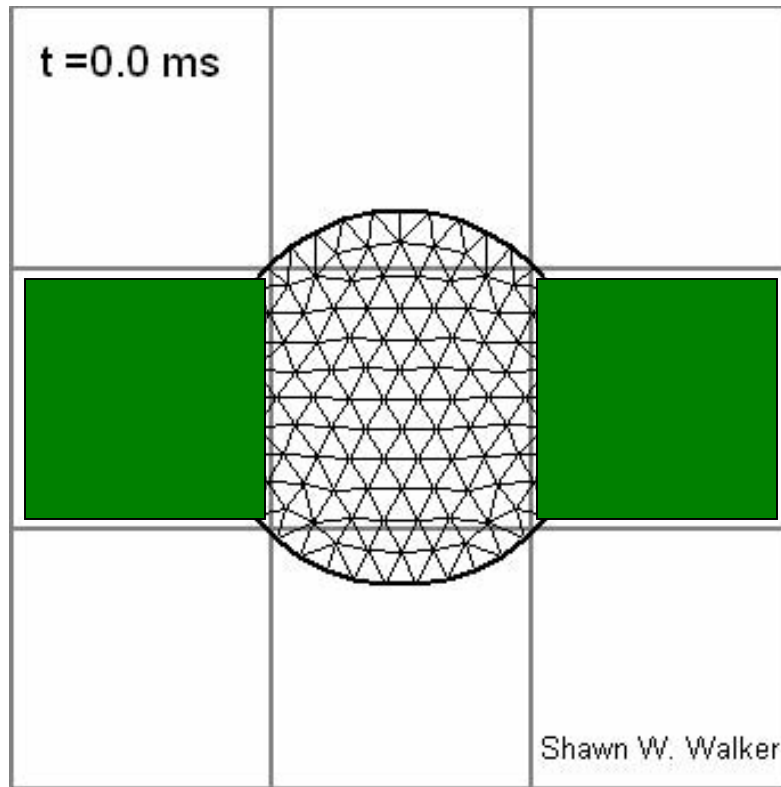

— free
— pinned

Need to clean up numerics + compare to UCLA experiments.

- Faster algorithm to find pinned/free regions. Convergence is too slow.
- Implement a good strategy to recreate FEM mesh after level-set tracks split/merge event.
- Splitting/merging from first principles. We *are* mesh invariant but split still based on level-set discretization. Incorporate Eggers Navier Stokes analytic split solution into simulation (hard).

[J. Eggers, "Universal Pinching of 3D Axisymmetric Free-Surface Flow," Physical Review Letters, vol. 71, pp. 3458-60, 1993.2131.]

This was the process by which we came up with physical effects, equations, and then numerical methods to model electrowetting. This took 6 years.

Finally, and most importantly, our models are *useful!*

Based on these models, we can create controllers for electrowetting systems.

e) Using the models: e.g. for particle steering control

Shawn Walker
Benjamin Shapiro

Can control the flow so as to precisely steer particles emmersed in the liquid
Have already shown this experimentally for electroosmotic flow actuation.

Sense current state, compare to desired state, actuate to correct for errors. Repeat.

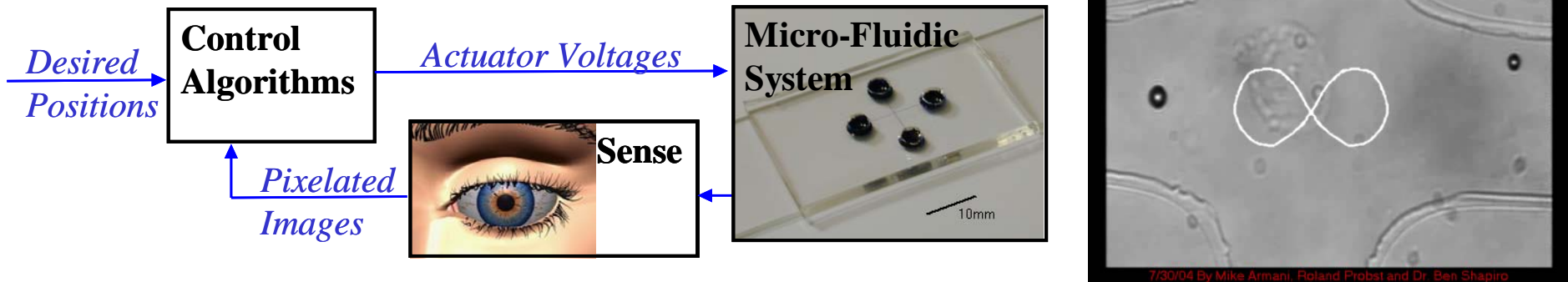

Do the same but now using electrowetting flow control.

Use the model to design the flow control algorithm. Same basic idea as above.

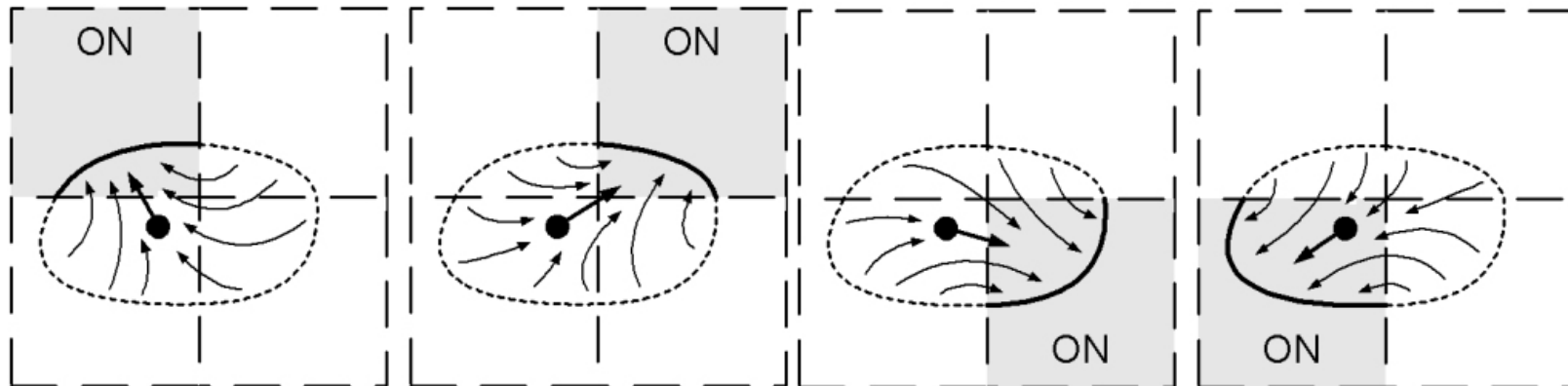

For any liquid shape, each overlapped electrode creates a flow. Model equations are linear (but dynamic) from boundary pressure to flow velocity → can superpose fields. Solve least squares problem to find voltage actuation that creates pressure that creates desired flow at each time.

e) Using the models: particle steering (in simulation)

Controllable cases (now trying experimentally @ UCLA)

Uncontrollable cases

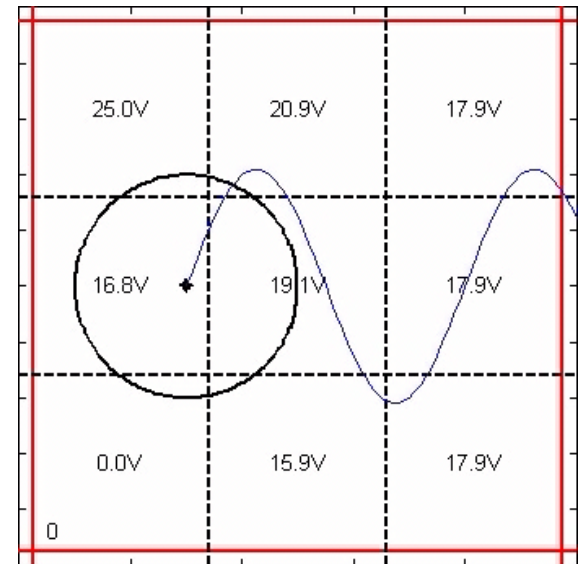
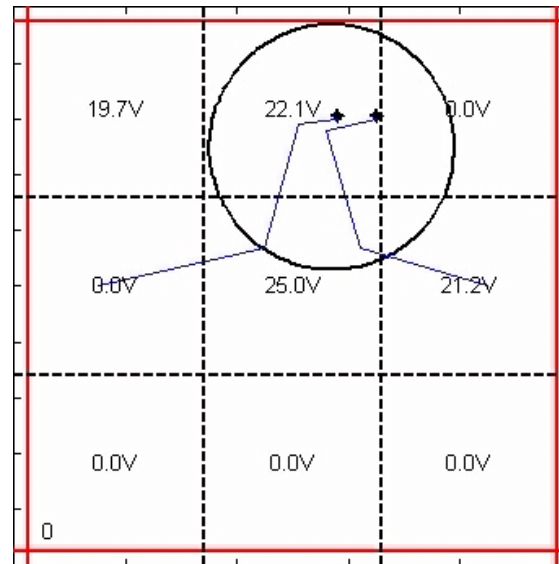
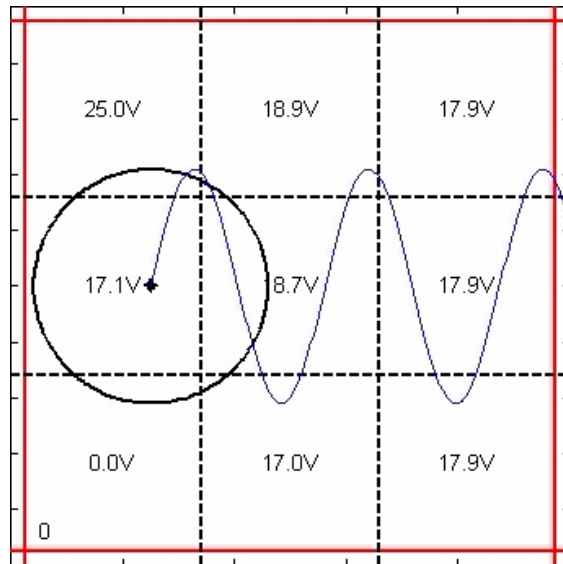
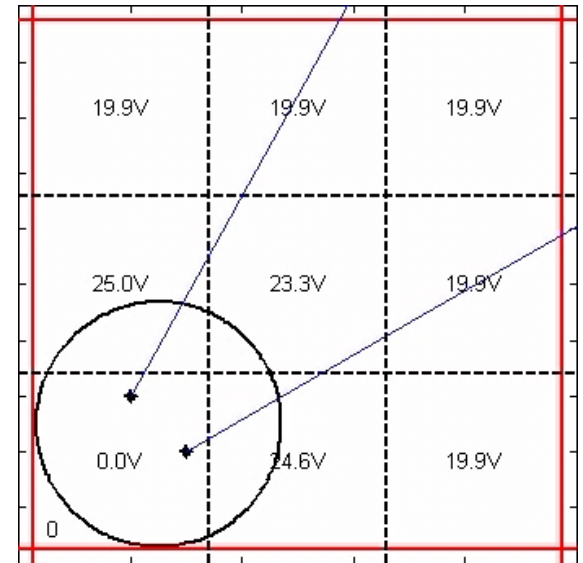
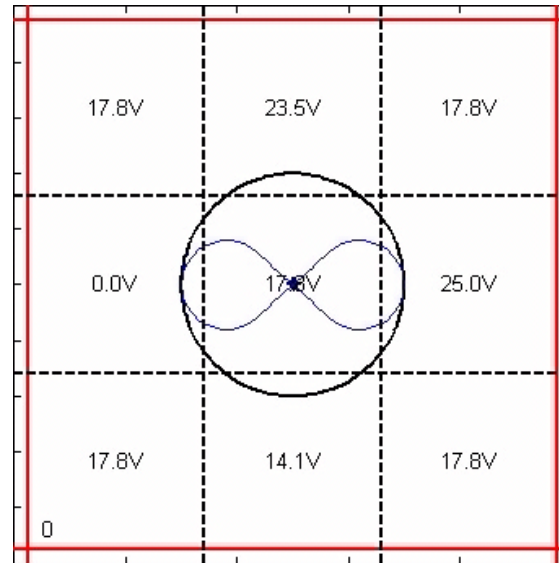
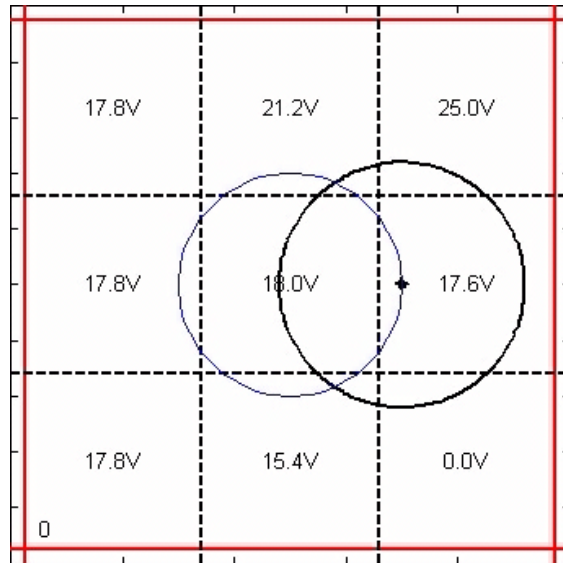

With actuation already in the UCLA EWOD system, can steer particles (needed model to see this)

Conjugated polymer actuators: a plastic that conducts electricity, can be micro-patterned, and can be actuated inside ionic solutions (e.g. in urine, blood).

with Elisabeth Smela



Conjugated Polymer Actuators

Elisabeth Smela, University of Maryland

Micro-Robot Arm

100 μm glass bead moved from here to there

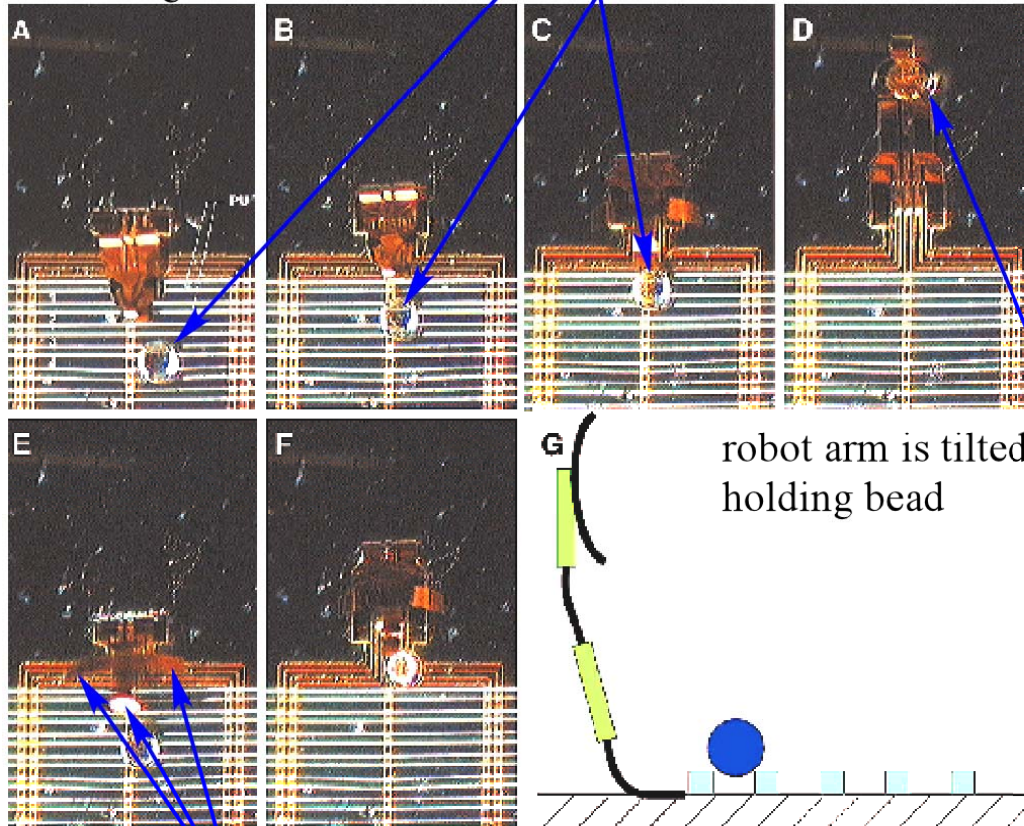

robot arm has three fingers

robot arm is tilted backwards, holding bead

E. W. H. Jager, O. Inganäs, and I. Lundström, "Microrobots for micrometer-size objects in aqueous media: potential tools for single-cell manipulation", *Science* **288**(5475), 2335-2338 (2000) .

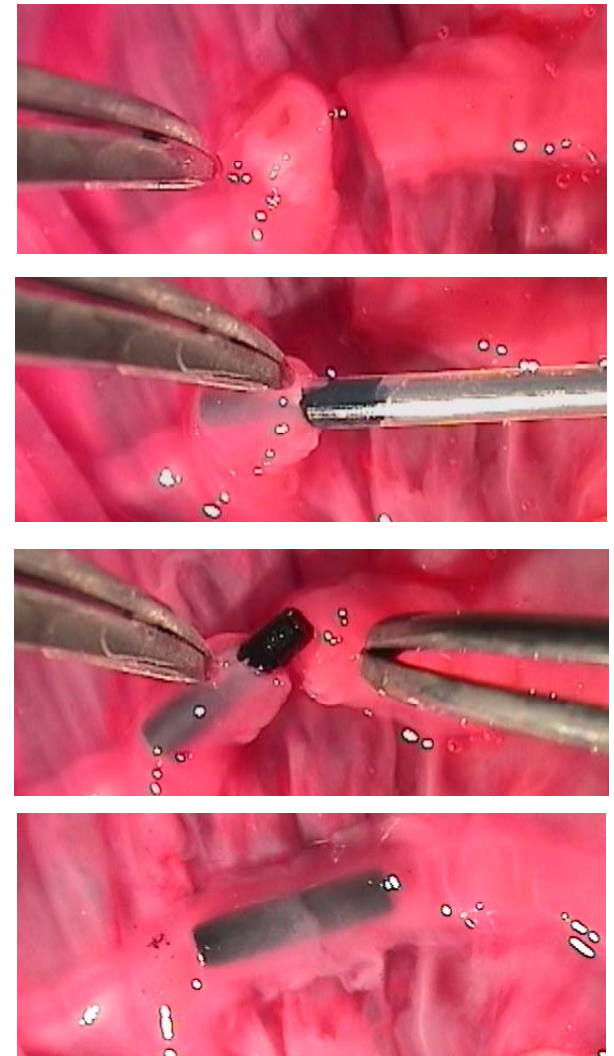

Elisabeth Smela



Redox: a Closer Look

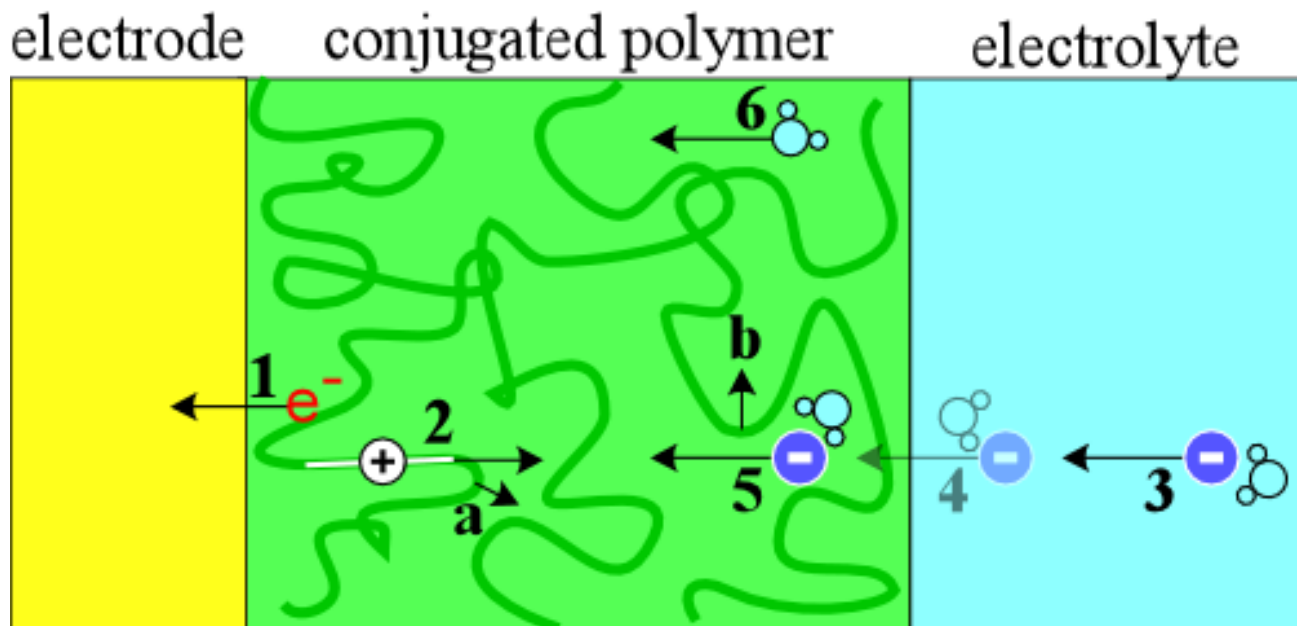

1. Electrons are removed from the polymer chains in response to the applied potential. This reaction can be the rate limiting step during slow cyclic voltammograms.



Redox: a Closer Look

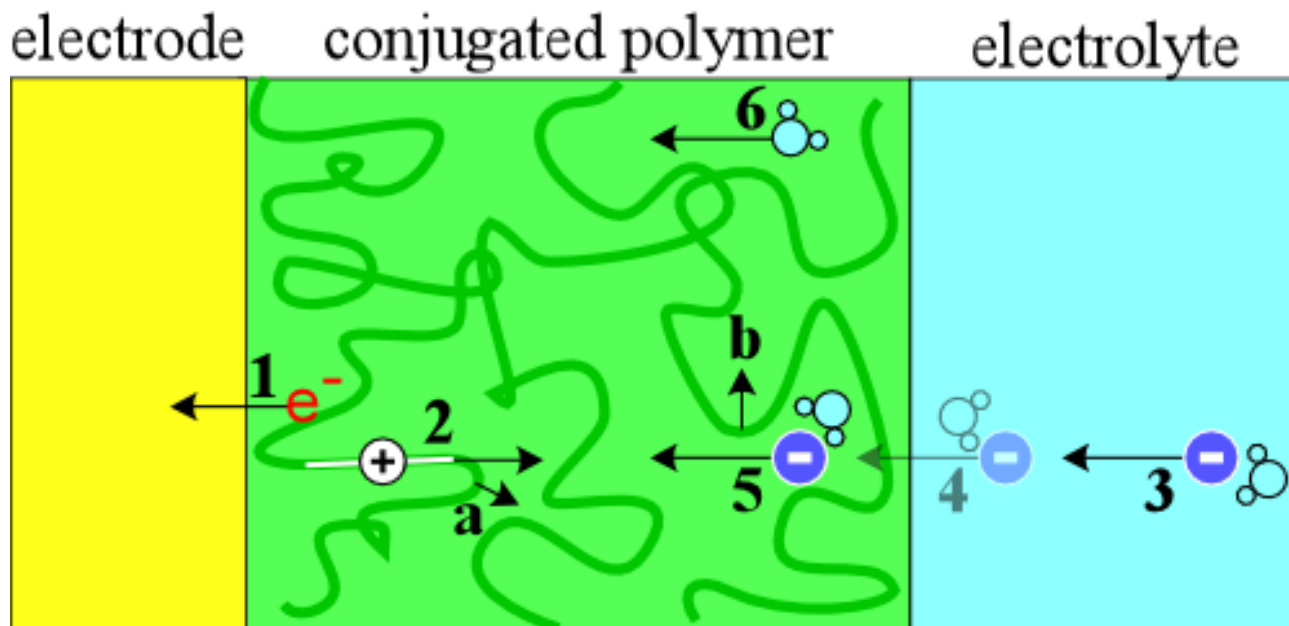

2. The resulting holes move along the polymer chains. This electronic current has drift and diffusion components, but diffusion can probably be neglected. Hole transport requires a local change in the distance between carbon atoms and a straightening out of the chain, so the hole current depends on chain movements (*a* in the figure). At defects, the hole must hop to an adjacent chain, which depends on the dielectric constant. Hole mobility is therefore not just a function of temperature, but also of the solvent and other parameters.



Redox: a Closer Look

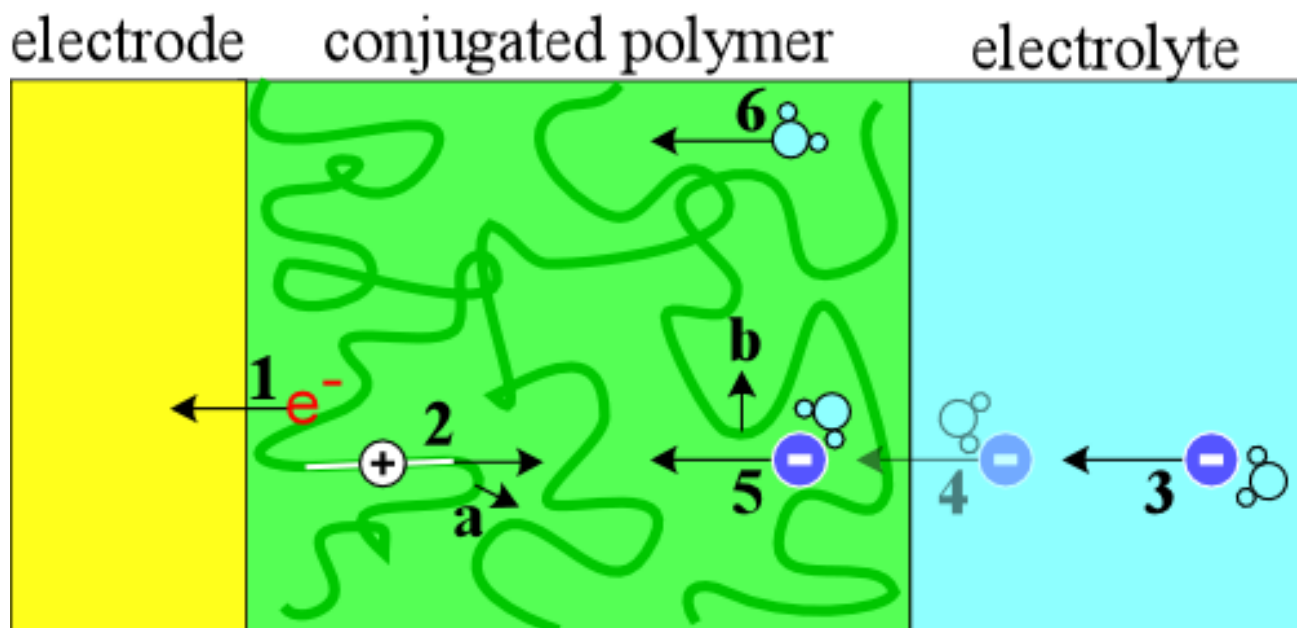

3. Ions in the electrolyte move toward the polymer surface by a combination of diffusion and drift. Drift is ignored in electrochemical systems because a concentrated electrolyte screens the electrode. However, the 3 M electrolyte concentration in the polymer may drain the electrolyte of ions. Therefore, anion migration in the electrolyte may not be negligible. The speed with which anions can be supplied from the electrolyte to the polymer depends on the temperature, concentration, and applied voltage.



Redox: a Closer Look

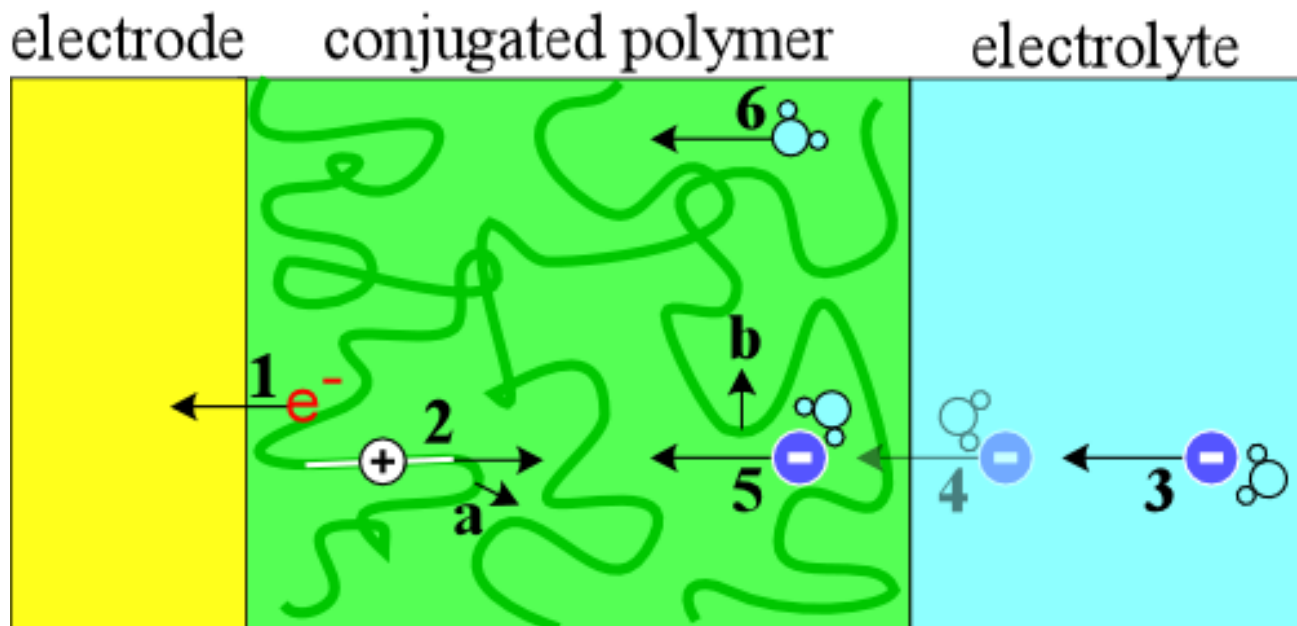

4. The ions enter the polymer. This step can probably be neglected unless the interface has special properties or causes something to happen, such as the shedding of some of the solvent molecules.

Standard electrochemical equations cannot be used.



Redox: a Closer Look

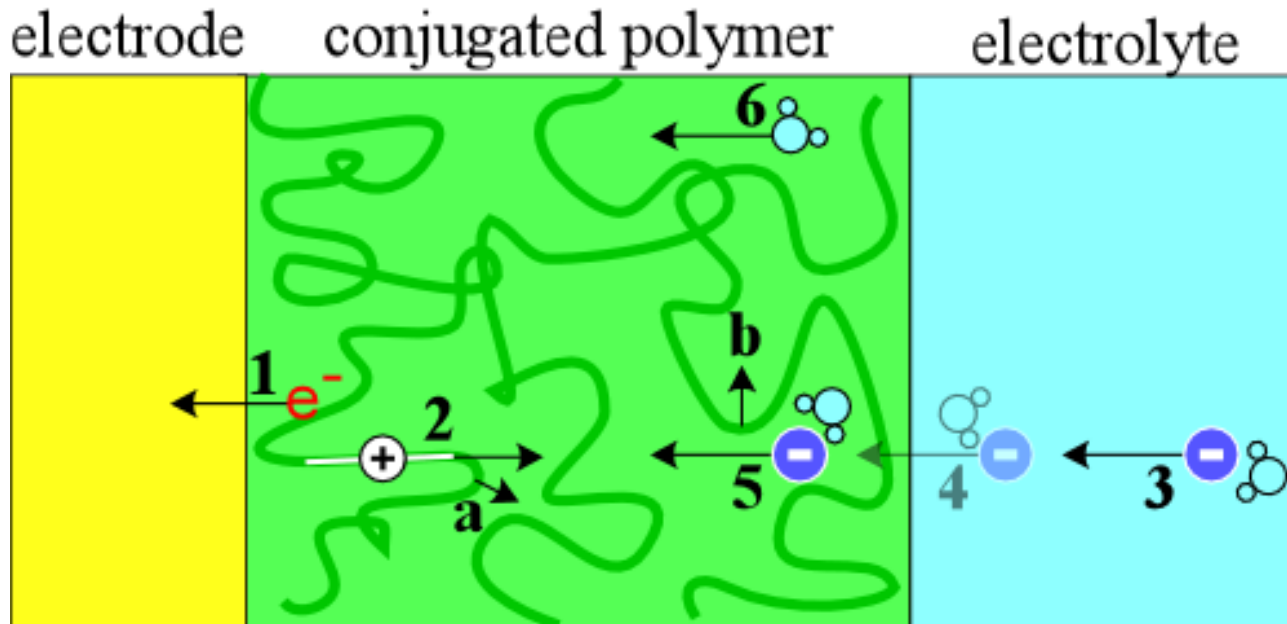

5. The ions move through the polymer, between the chains, by a combination of drift and diffusion; they may be solvated. Space between the polymer chains must be created, so the ion current depends on chain movements (***b*** in the figure), as well as on the degree of polymer solvation, ion size, extent of ion-polymer interaction, etc. Ion transport is most likely the rate-limiting step in most actuator experiments.



Redox: a Closer Look

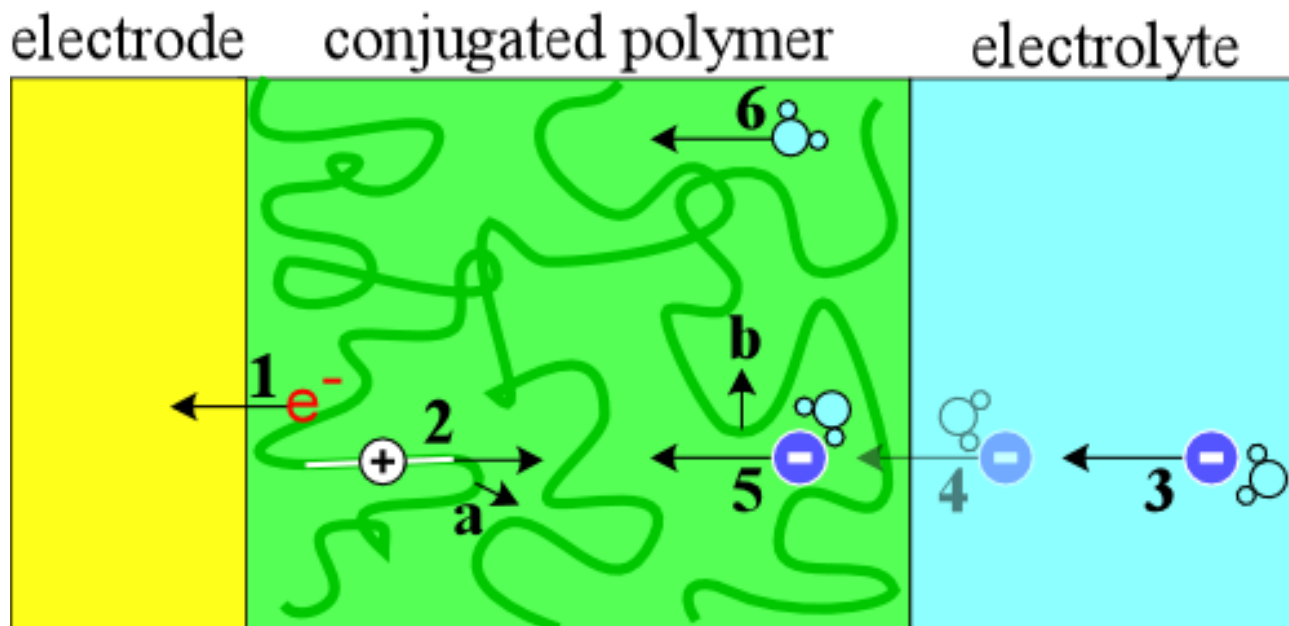

6. Solvent moves into the polymer that is not bound to ions but enters in response to osmotic pressure. It moves only by diffusion, since it is uncharged. The role of this solvent in actuation is still not clear, but may play a significant role.

The rate limiting step could be any of these steps, depending on the experiment.



Complex Physics

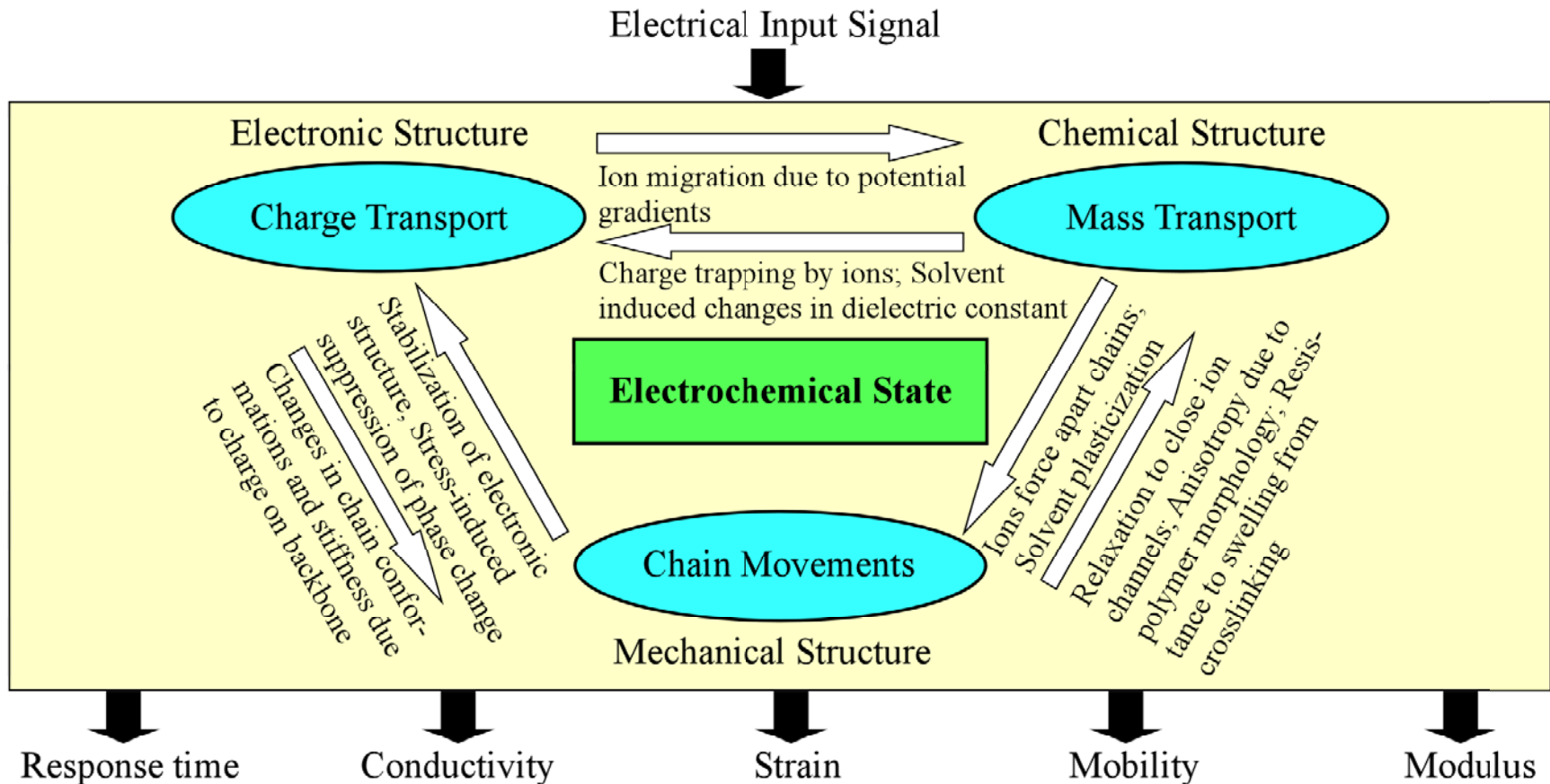

I will summarize on one slide how we went from this complex picture to the first ever *predictive first-principles* models of conjugated polymer actuation.

The list of possible physical effects is long (30 to 50 items, from chain motion hysteresis to ion solvation to electrons jumping on and off the polymer backbones).

Each effect could be a PhD thesis in itself.

Sadly, in fact, there are PhD dissertations on some unimportant/useless physical effects (e.g. empirical telegraph resistor models, quantum mechanics of chain reconfirmation due to one or two electrons on a chain [in vacuum, with 10 electrons]) that we know are useless (negligible, wrong idealizations, irrelevant, etc).

Basically



*Elisabeth Smela,
encyclopedic
knowledge of CPs*

+



*me, dumb
questions about
CP physics*

=

Educated guesses on dominant (a small sub-set of important) physical phenomena

- Electron migration under electric fields + diffusion
- Ion migration under electric fields + diffusion
- Electrostatics driven by net charge = ion – electron.

Turns out these guesses capture 85% of the CP behavior (see next slides).

Reason: *We are not so unlucky that all possible effects are equally large.*

Some few dominate.



Model Development

Step 1: Formulate Preliminary Model for Charge Transport

Ion drift and diffusion:
$$\frac{\partial C}{\partial t}(\vec{x}, t) = \nabla(D_c \nabla C(\vec{x}, t) + \sigma_c \nabla \phi(\vec{x}, t))$$

Hole drift (and diffusion):
$$\frac{\partial n}{\partial t}(\vec{x}, t) = \nabla(D_n \nabla n(\vec{x}, t) - \sigma_n \nabla \phi(\vec{x}, t))$$

Drift driven by electric field:
$$\nabla(\kappa \nabla \phi(\vec{x}, t)) = \frac{C(\vec{x}, t) - n(\vec{x}, t)}{\epsilon_0}$$

But what are D_c , μ_c , and σ_c in the polymer? And how do they depend on:

- oxidation level
- preparation conditions
- electric field
- solvent
- ion type?

How are they related to each other? Can we use standard semiconductor equations?

$$D/\mu = kT/q \quad \sigma = qn\mu$$

We already know that these coefficients are a function of oxidation level, and that diffusion is non-Fickian...

Even for “simple” behavior, physics is complex. Concentrate on dominant effects.



Model Development

Step 2: Perform experiments designed to answer specific questions.

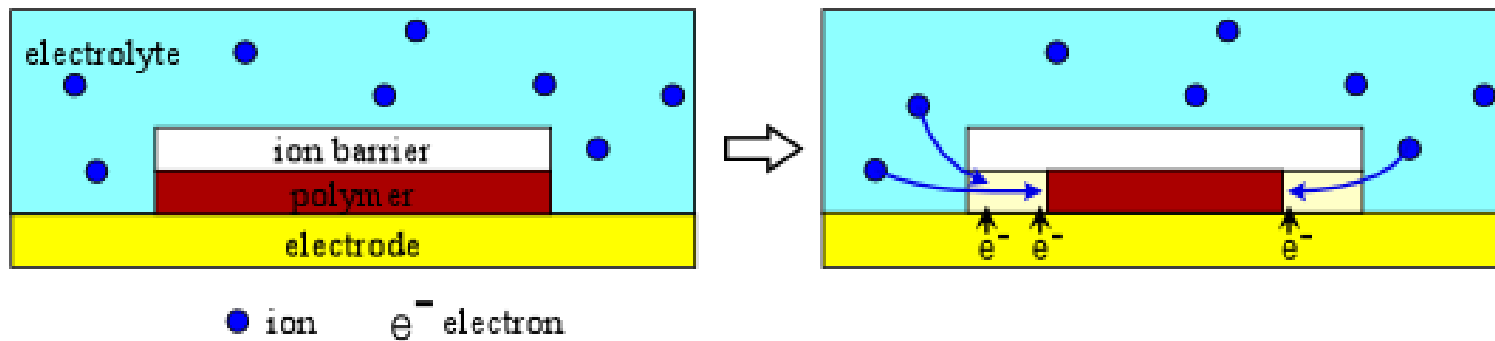

Use the fact that PPy is electrochromic to visualize the phase boundary

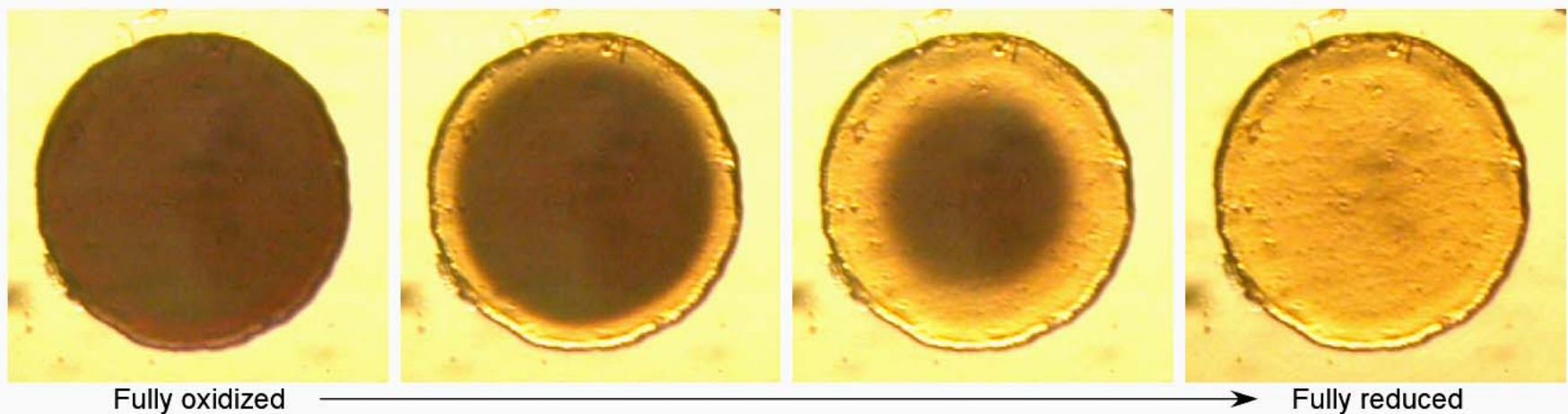



Model Development

Step 3: Compare model predictions with experiments.

Simulate ions + E field only. Predicted front shapes vs measured front shapes:

$$\frac{\partial C}{\partial t}(\vec{x}, t) = \nabla(D_C \nabla C(\vec{x}, t) + \sigma_C \nabla \phi(\vec{x}, t))$$

$$\nabla(\kappa \nabla \phi(\vec{x}, t)) = \frac{C(\vec{x}, t) - n(\vec{x}, t)}{\epsilon_0}$$

$$n(\vec{x}, t) = n_0 = \text{constant electron conc}$$

(The tentative part is link between measured color intensity and the actual ion concentration.)

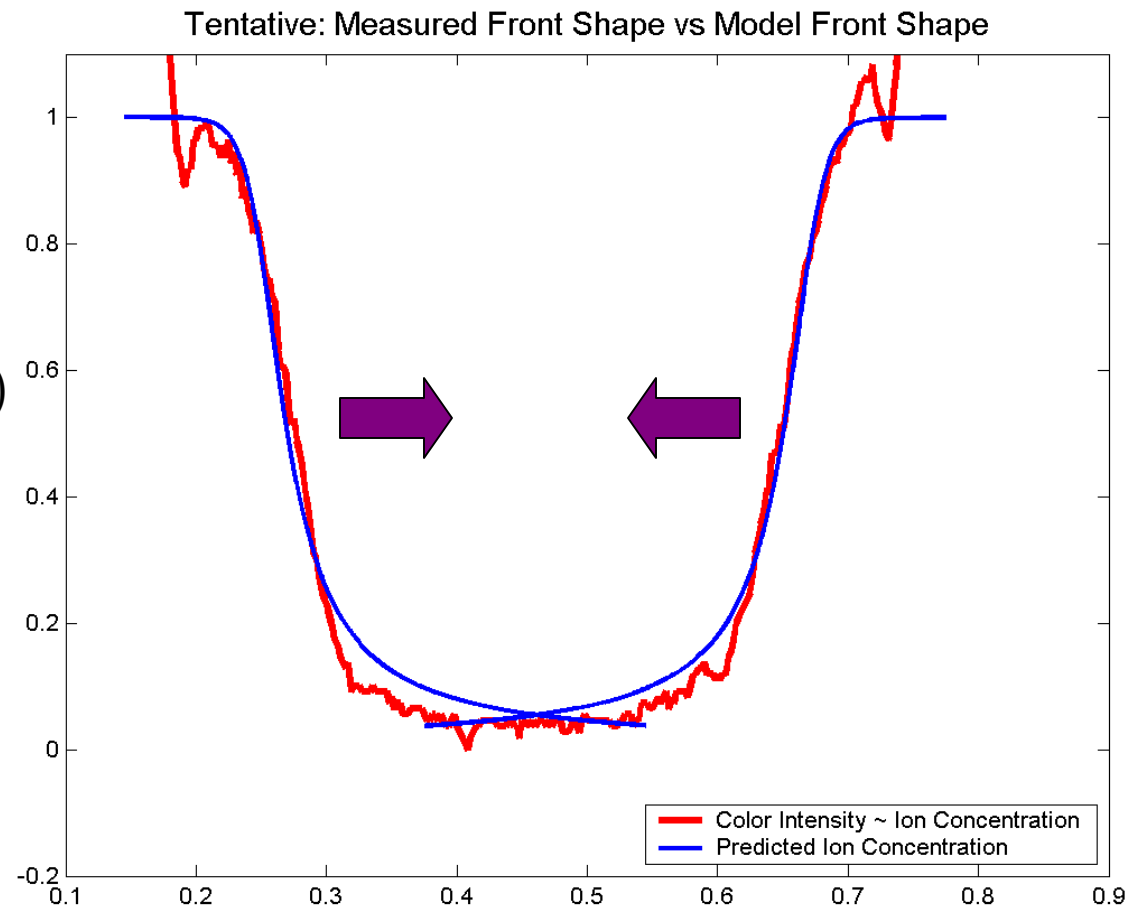



Model Results

Even very simple models can show very interesting/realistic results.

If you solve subset of the previous model (just ion drift/diffusion + electric field, hole distribution is constant) in one spatial dimension with constant coefficients:

Low Diffusion: Diffusivity \ll Mobility High Diffusion: Diffusivity \sim Mobility

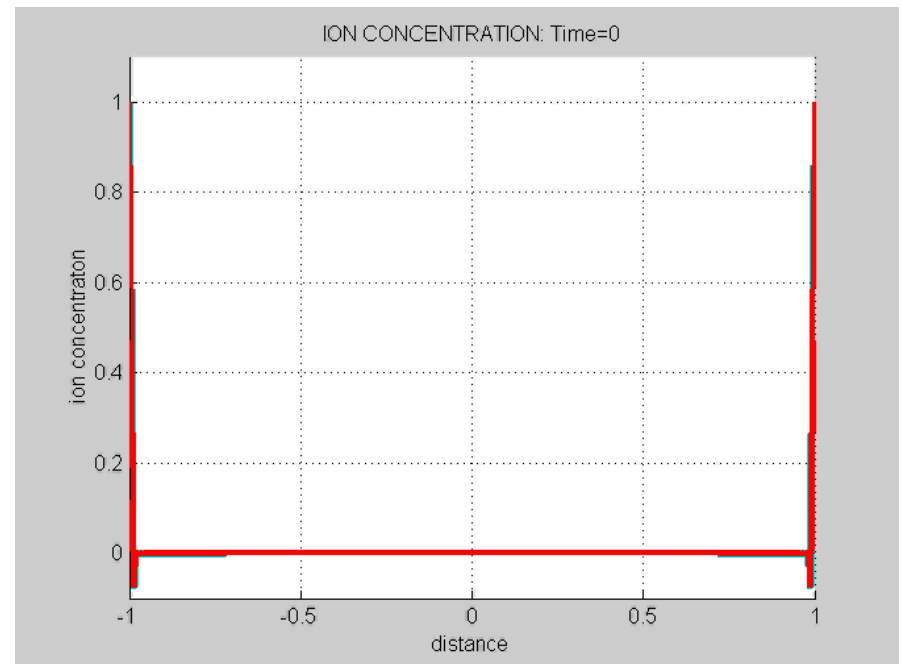
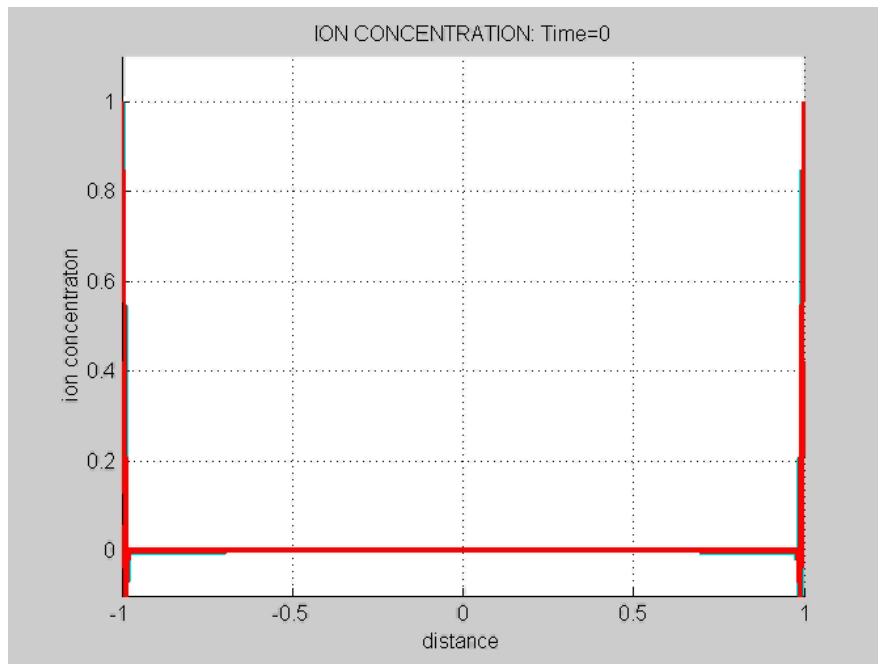

Compare experiment and theory so far ...

Low applied voltage:
creates low electric field so mobility of ions \ll diffusion of ions.

High applied voltage:
creates high electric field so mobility of ions \sim diffusion of ions.

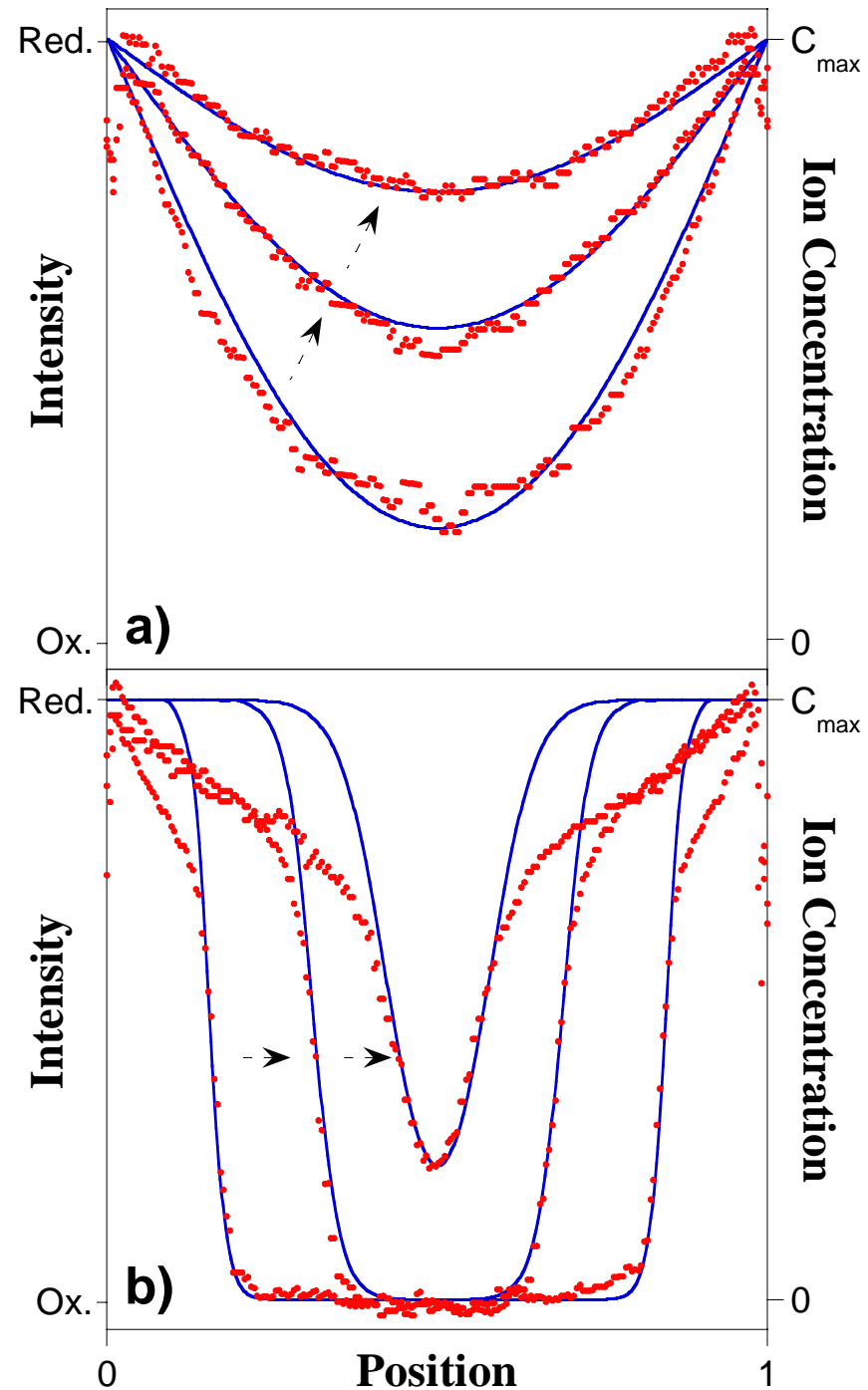

Derivation of governing equations (so far) in 2 dimensions ...

Conservation of species (exact): $\frac{\partial C_i}{\partial t} = -\nabla \cdot \vec{J}_i$

Flux = diffusion + drift
(the physical assumption) $\frac{\partial C_i}{\partial t} = -\nabla \cdot \vec{J}_i = -\nabla \cdot (-D_{C_i} \nabla C_i - \mu_{C_i} C_i \nabla \phi)$

Electrostatics: $\epsilon_0 \nabla(\epsilon \nabla \phi) = Q = C - n, \quad \vec{E} = -\nabla \phi$

Options for net charge (depending on chemistry of materials):

(+) mobile ions, (+) mobile holes, (-) immobile background: $Q = C + n - 1$

(-) mobile ions, (+) mobile holes, no immobile charge: $Q = n - C$

And boundary conditions:

		liquid
$C_i = C_o$ $\vec{J}_n \cdot \hat{n} = 0$ $\phi = 0$	$\frac{\partial C_i}{\partial t} = -\nabla \cdot \vec{J}_{C_i} = -\nabla \cdot (-D_{C_i} \nabla C_i - \mu_{C_i} C_i \nabla \phi)$ $\frac{\partial n}{\partial t} = -\nabla \cdot \vec{J}_n = -\nabla \cdot (-D_n \nabla n - \mu_n n \nabla \phi)$ $\epsilon_0 \nabla(\epsilon \nabla \phi) = Q = C - n$	polymer
electrode	$\vec{J}_{C_i} \cdot \hat{n} = 0, n = f(\phi), \phi = -V$	

2-Dimensional models to understand effect of device geometry

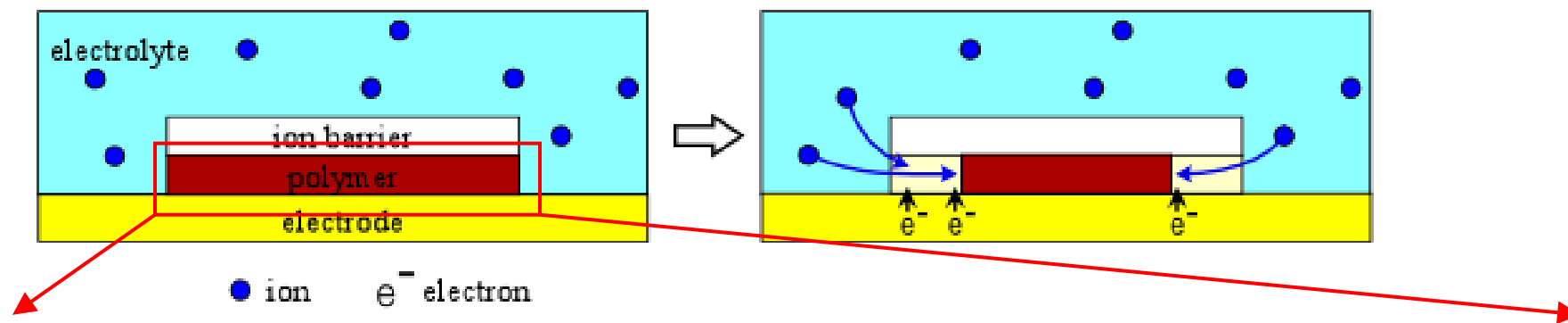

Electron (hole) transport

Ion transport

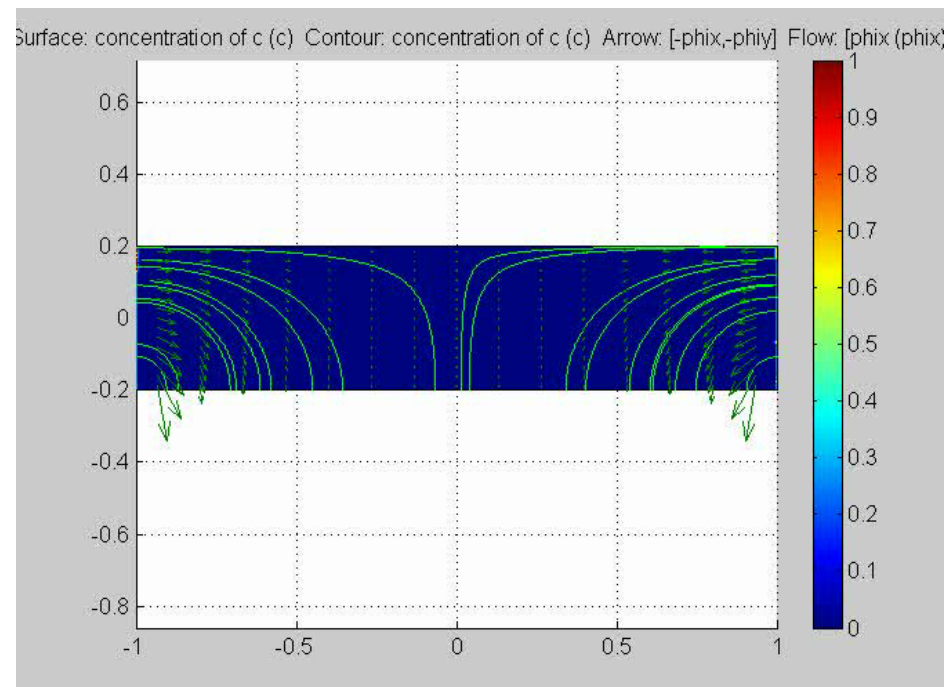
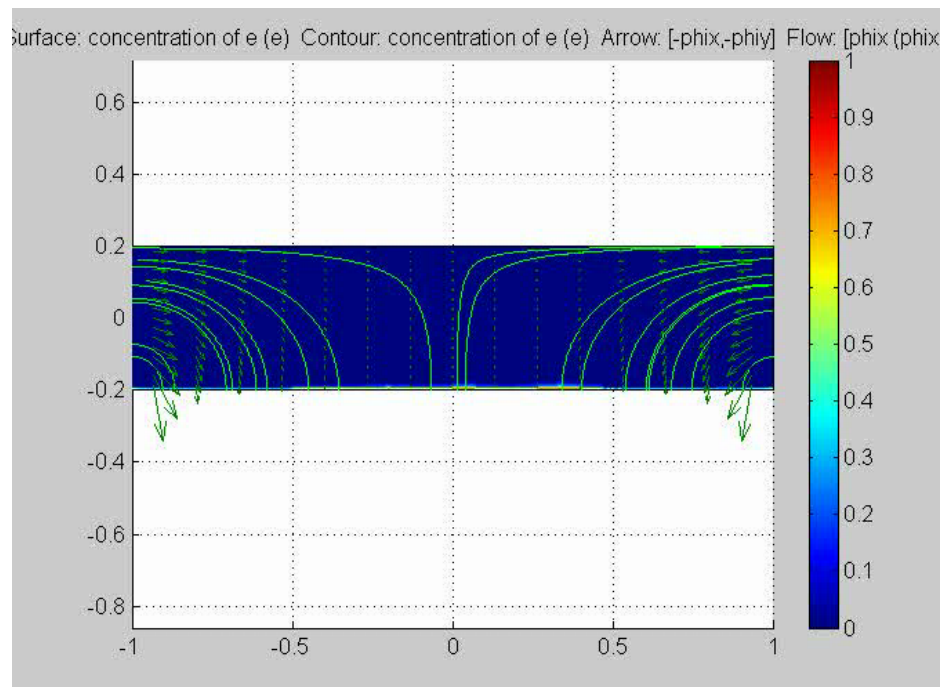

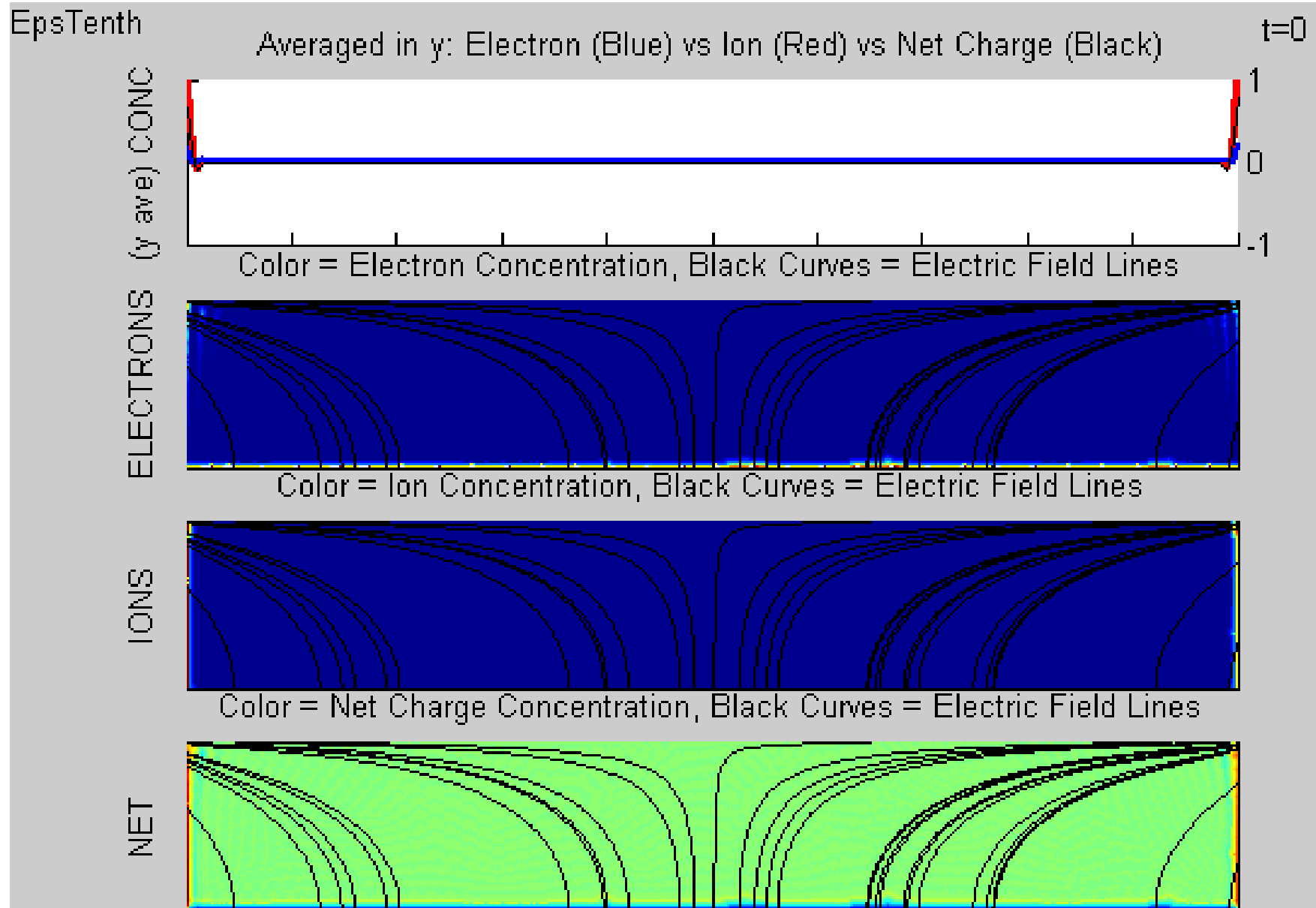

I'll end with some suggestions on how I think we should proceed to do the same for living cells.

We need a systematic way to get to *equations* we can model, that are appropriate for answering questions about *living cells* (lipid vesicles useful as a stepping stone).

ASK RIGHT QUESTION

What question will we be asking of the models?

e.g.

- Use model to infer if cell is sick (malarial, cancerous, ...) by mechanical probing.
- Use model to infer drug effect on cell membranes from mechanical measurements.
- ...
- ...

End target question must be clinically relevant else we won't find funding (NIH must care), collaborators (they must care), and me (if this project has no clinical relevance it will fall off my radar screen).

Is ok to answer such questions in +5 years, but path to them must exist.

GENERATE LIST OF POSSIBLE PHYSICAL PHENOMENA

- Lipid bending energy
- Cytoskeleton
- Microtubule growth
- Internal fluid forces
- ...
- ...
- ...
- Adhesion of membrane to surfaces?
- ...
- ...
- Thermal fluctuations important?
- ...
- ...
- ???
- ...

Using info from cell-biologists, experiments, literature, and intuition

Need to be able to search through possible effects fairly quickly. Back-of-envelope (good), vs. detailed models for each effect to then compare with exp's (too slow)

DOWN-SELECT TO LIST OF DOMINANT PHENOMENA (NOT JUST IMPORTANT)

- Lipid bending energy?
- Cytoskeleton?
- ???
- ...

EQUATIONS, NUMERICAL METHODS

I'm sorry to be blunt, but here is what we have right now ...

